

13

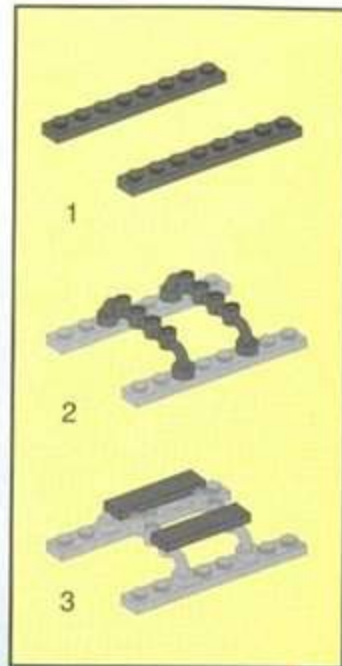

15

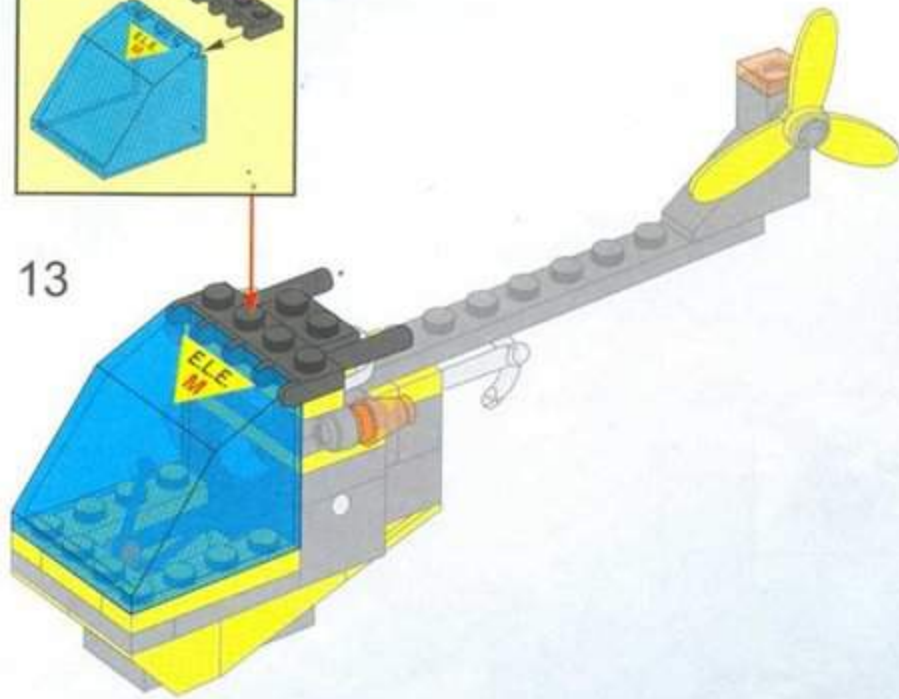
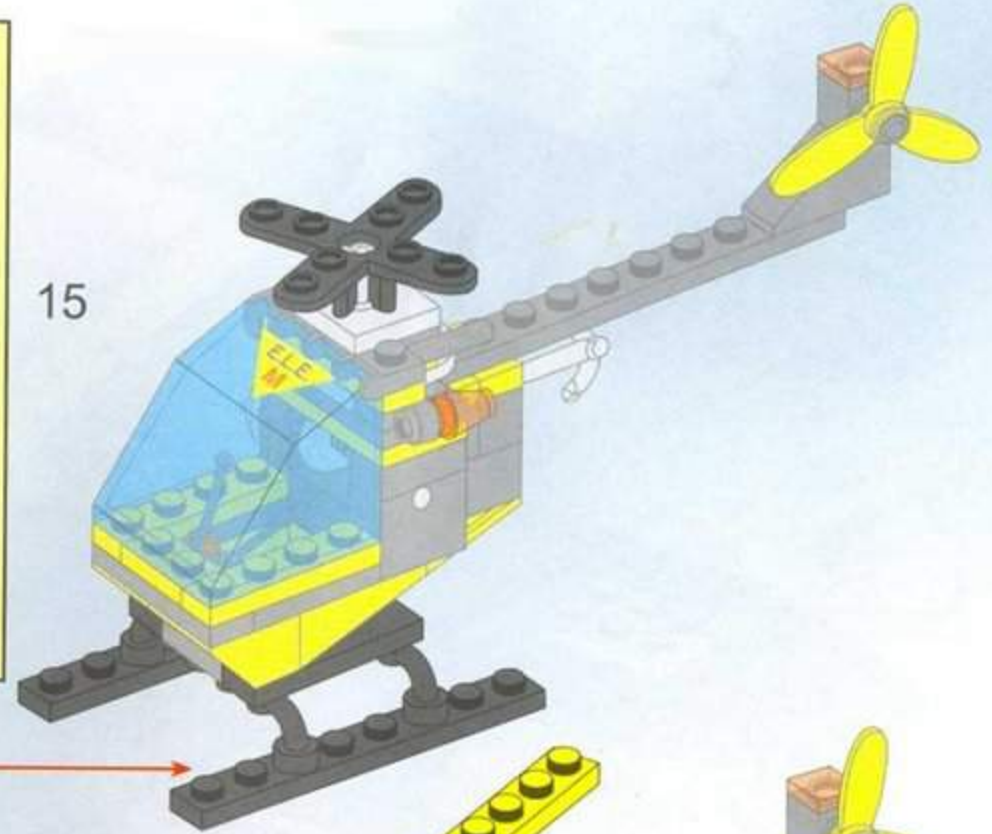

14

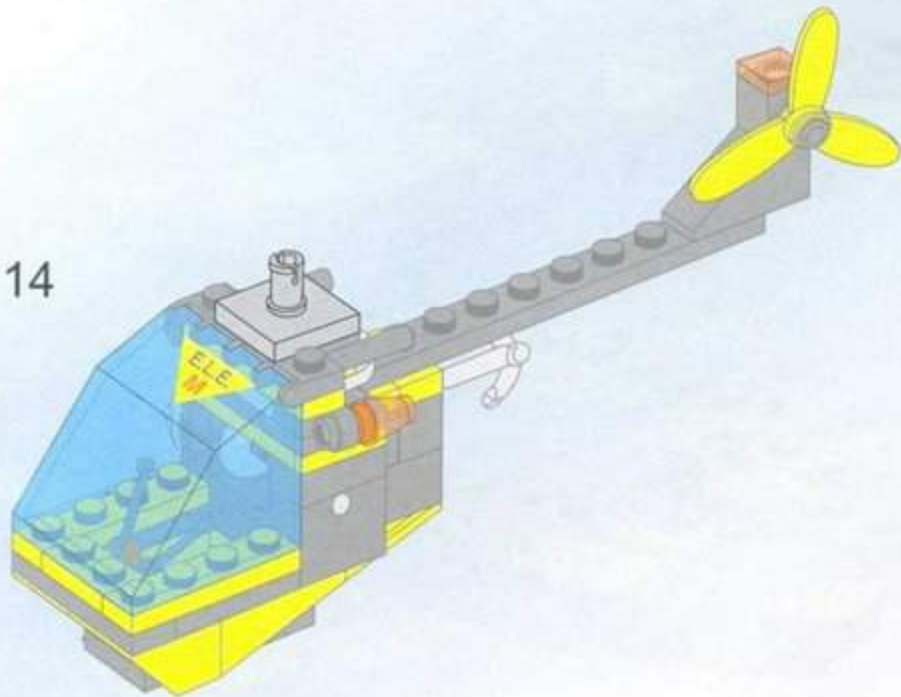

16

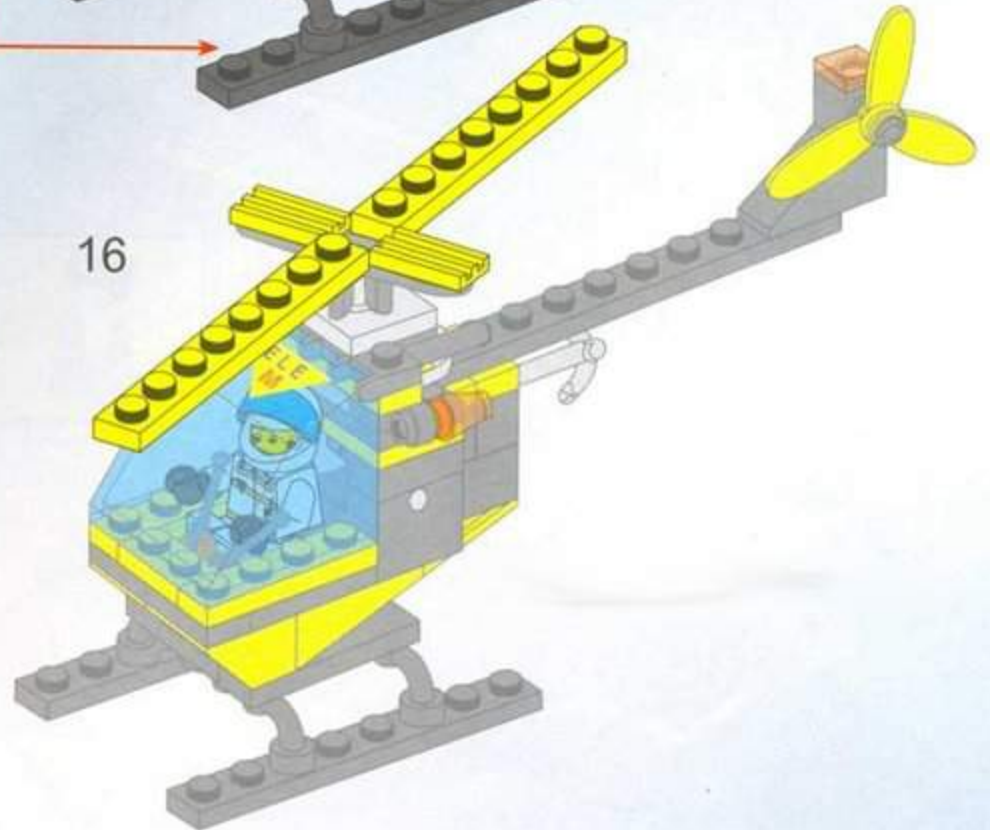

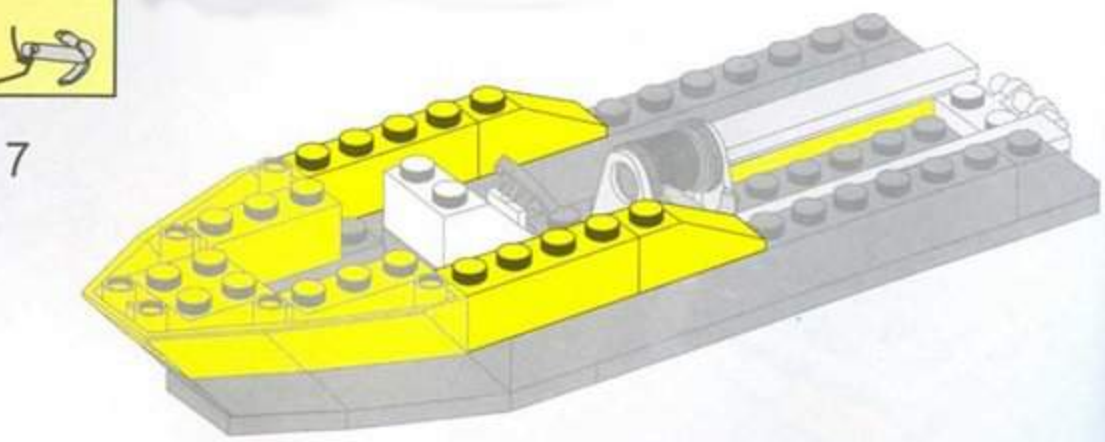
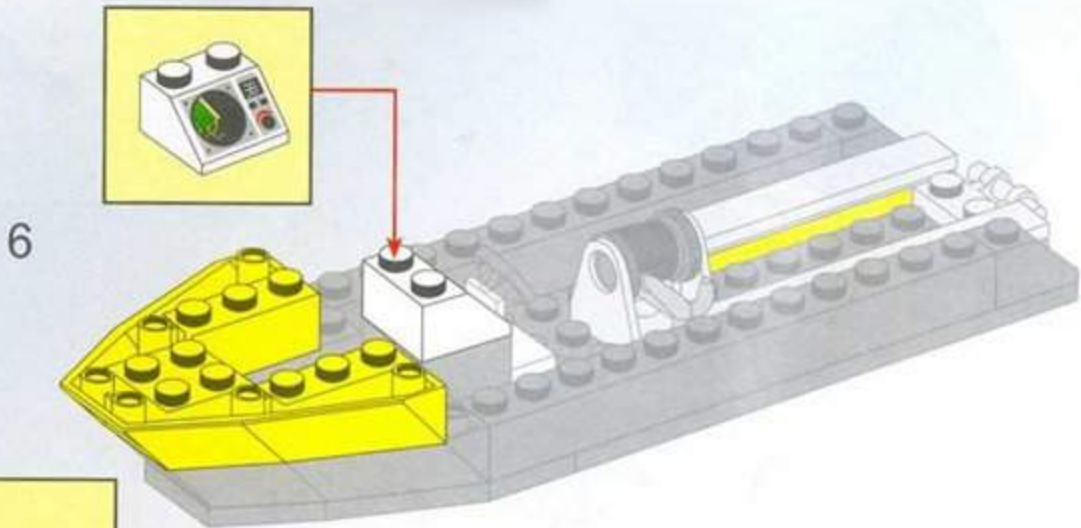
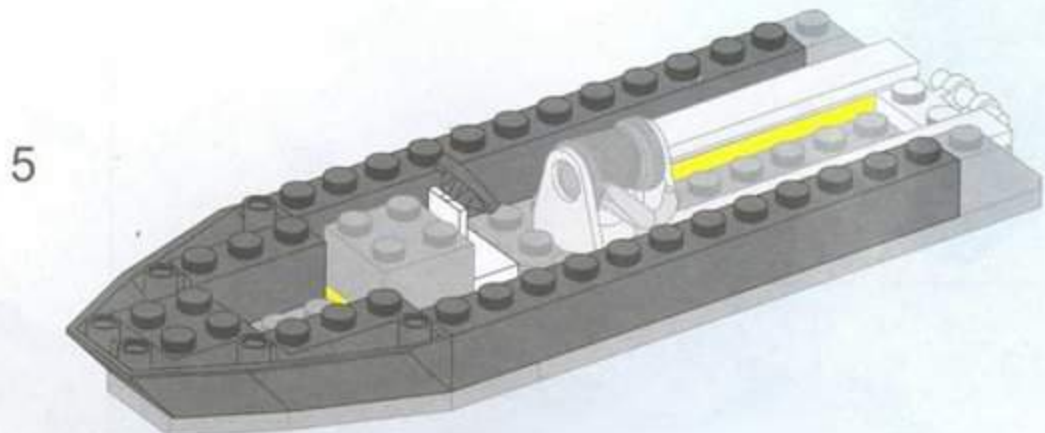
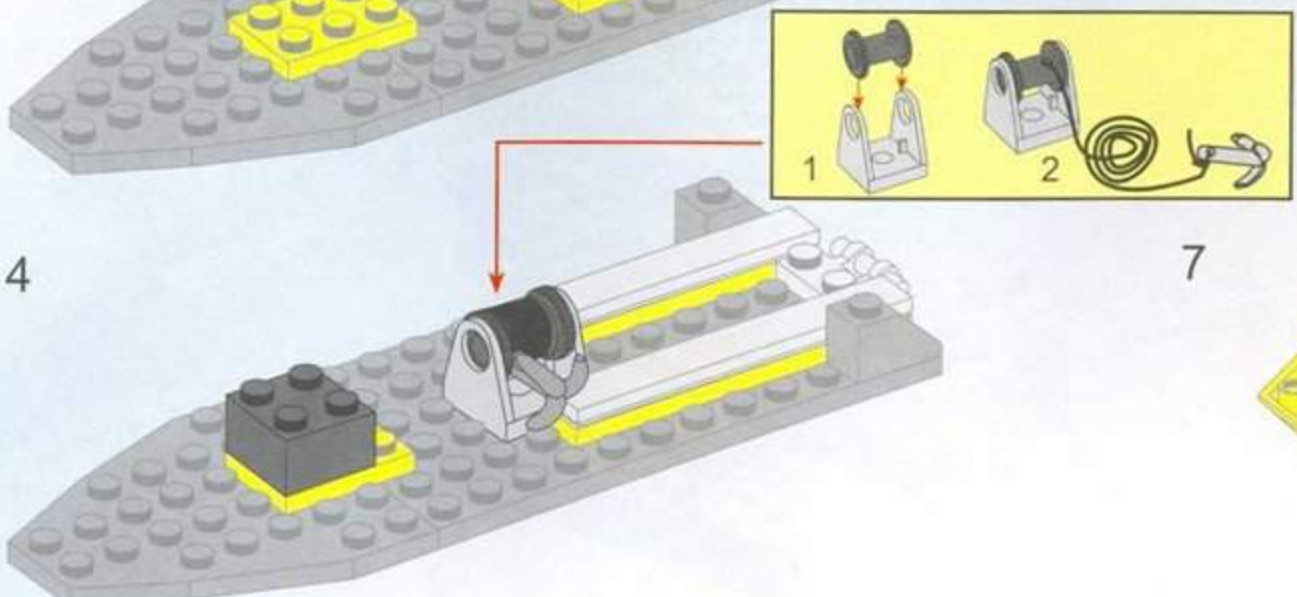
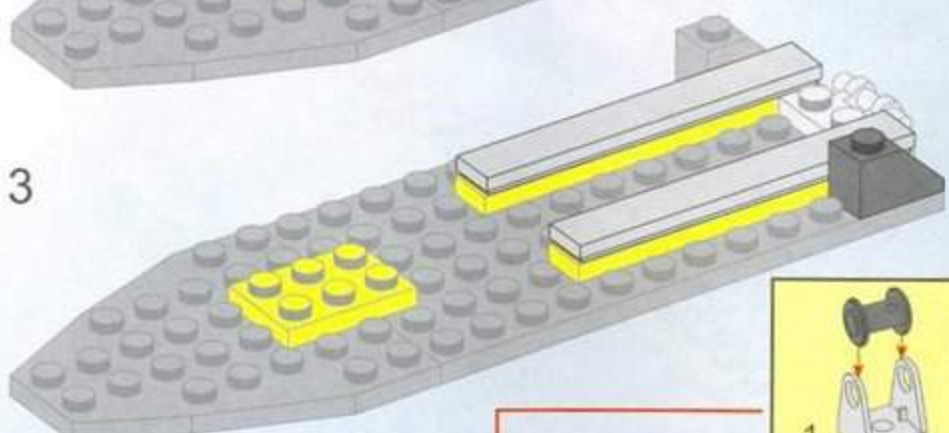
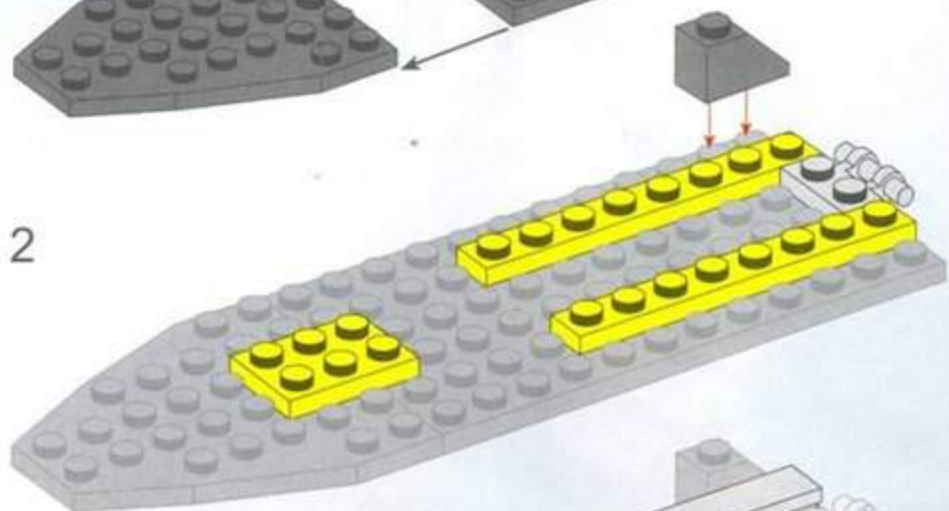
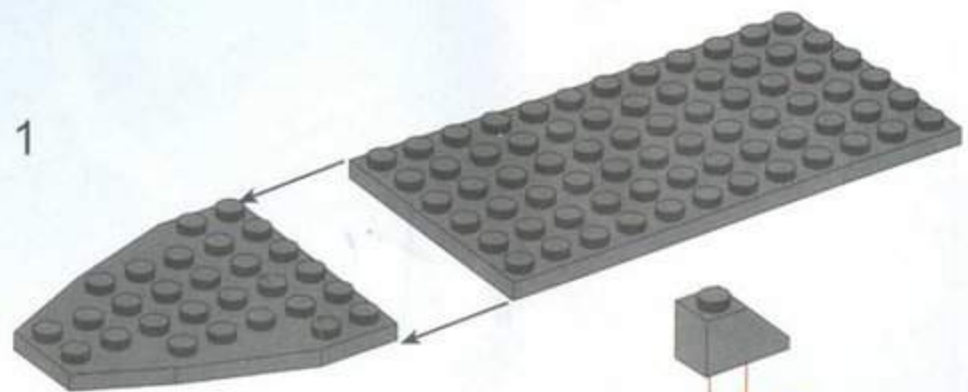

8

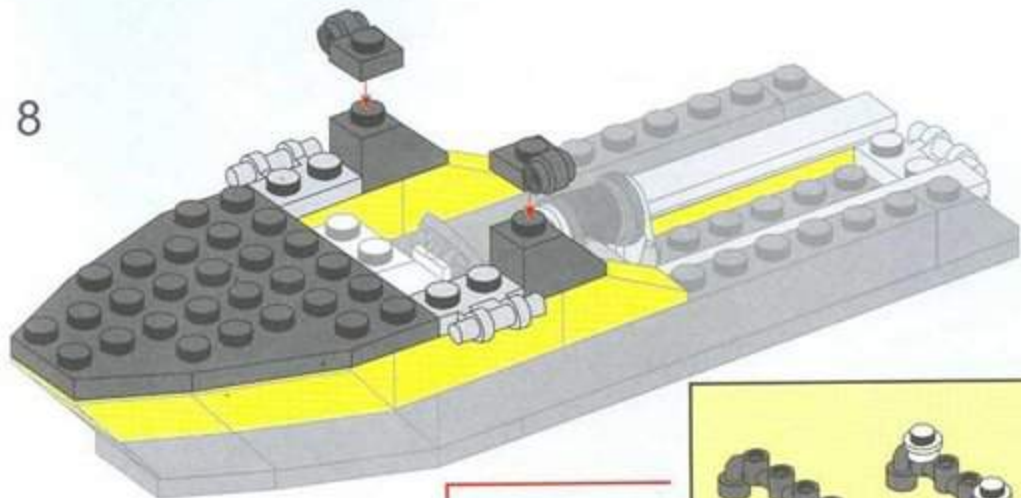

9

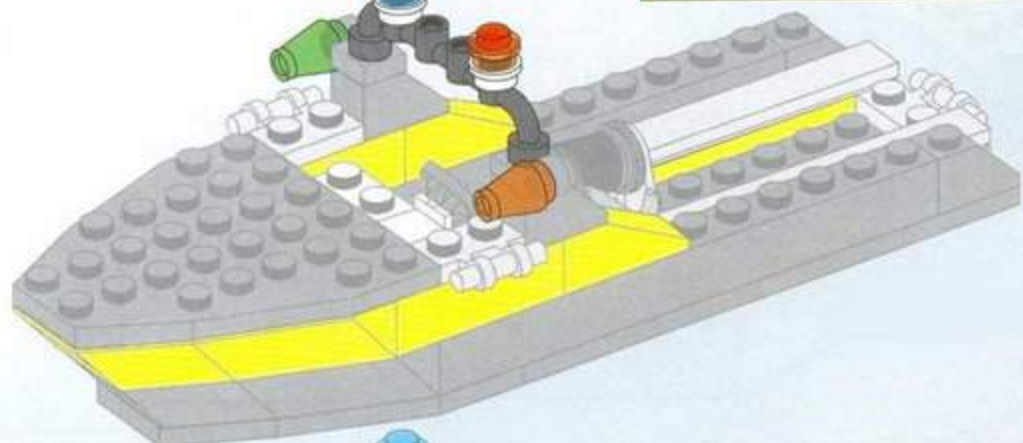

10

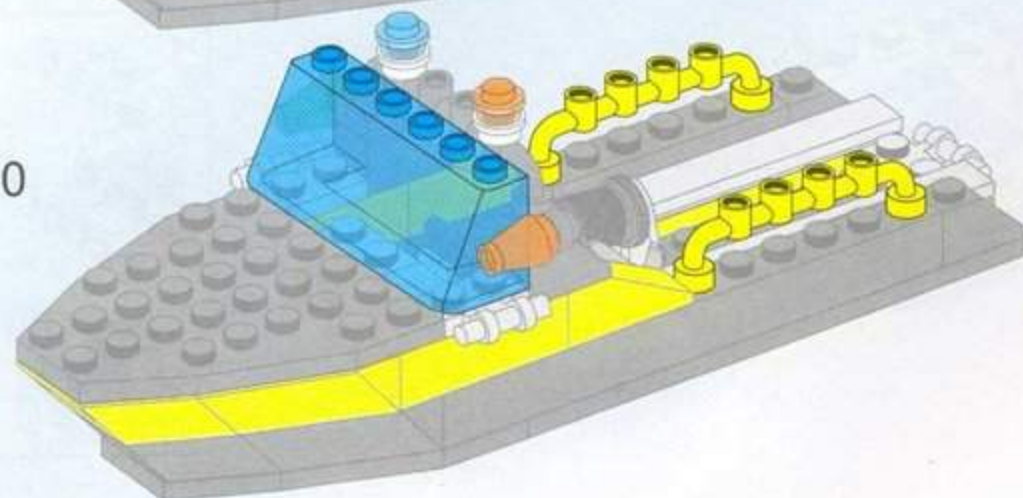

11

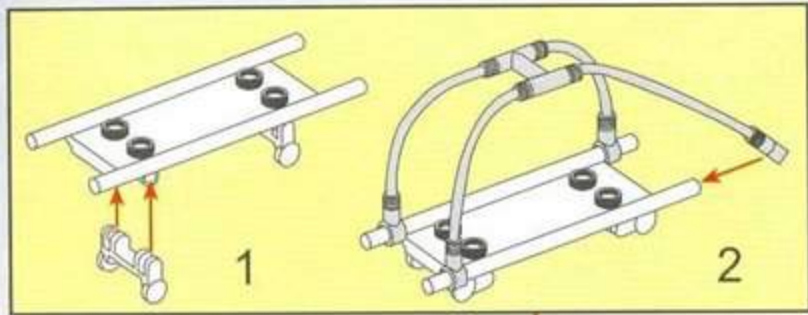
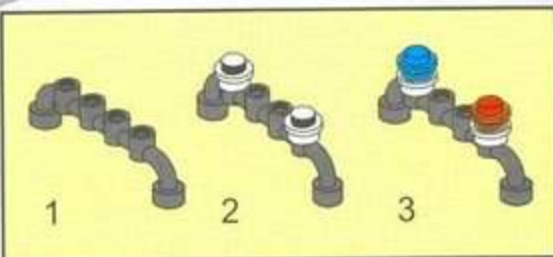
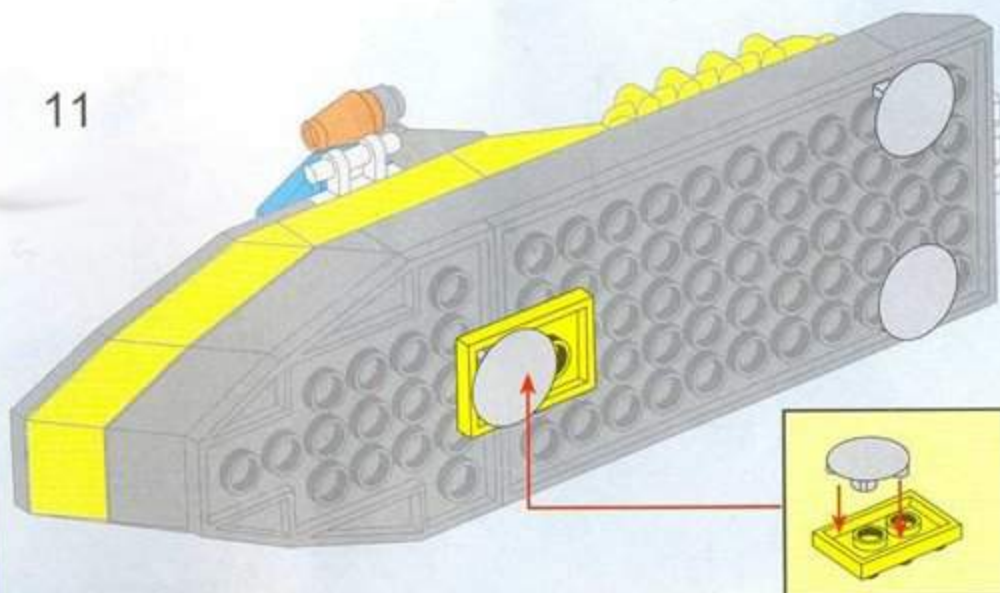

12

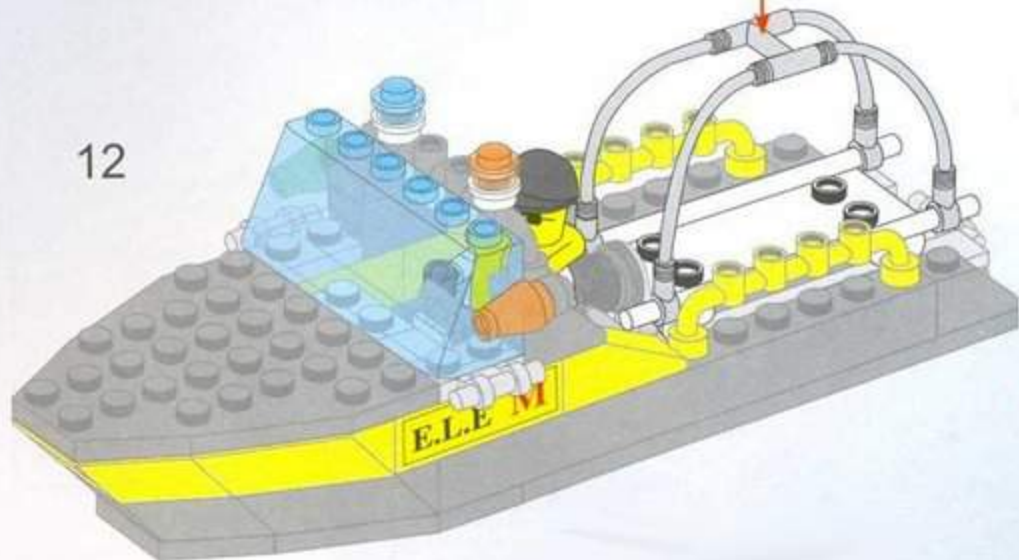

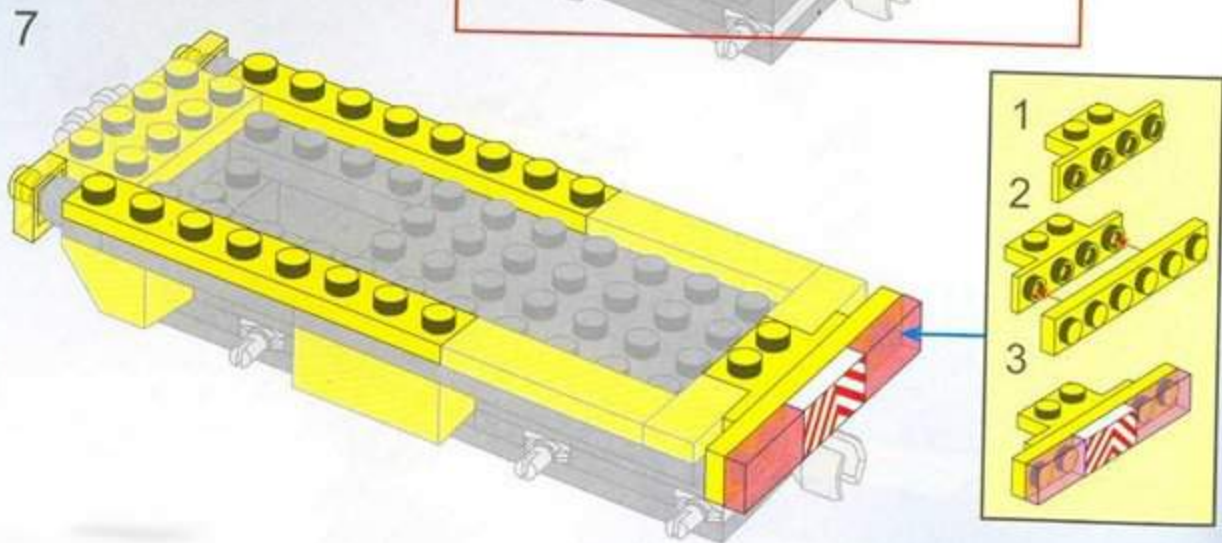
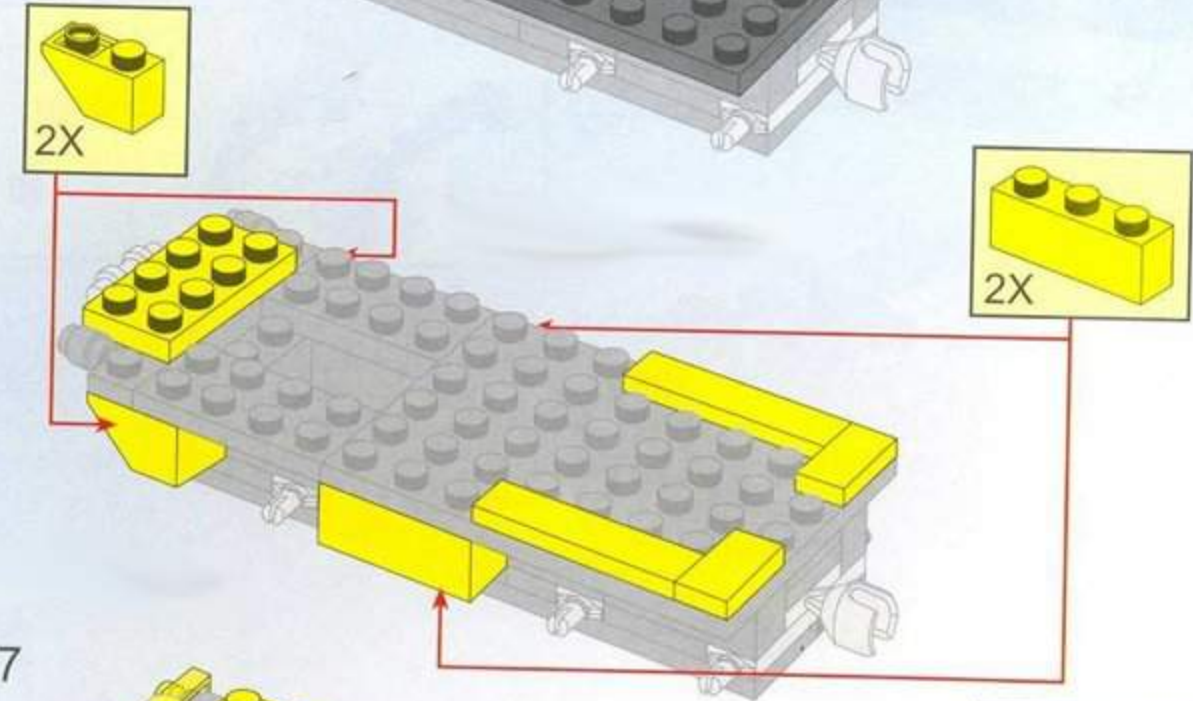
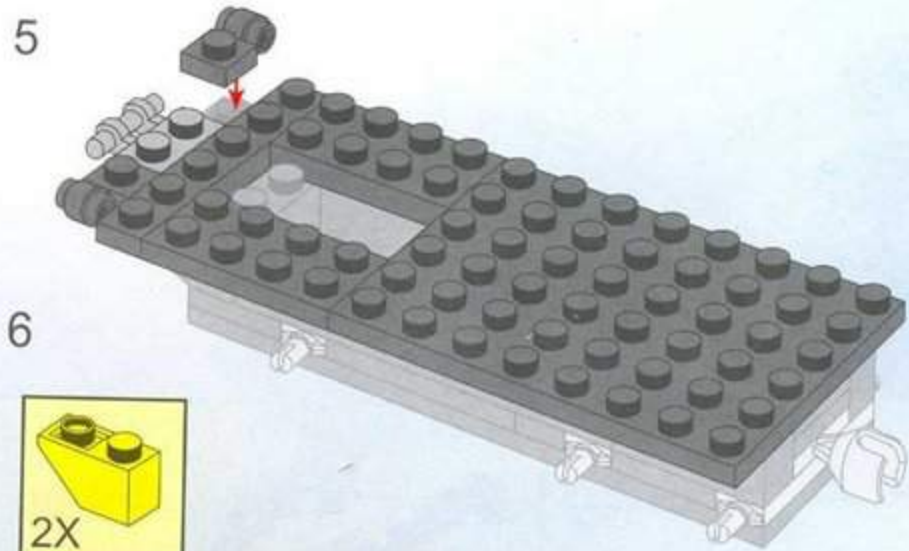
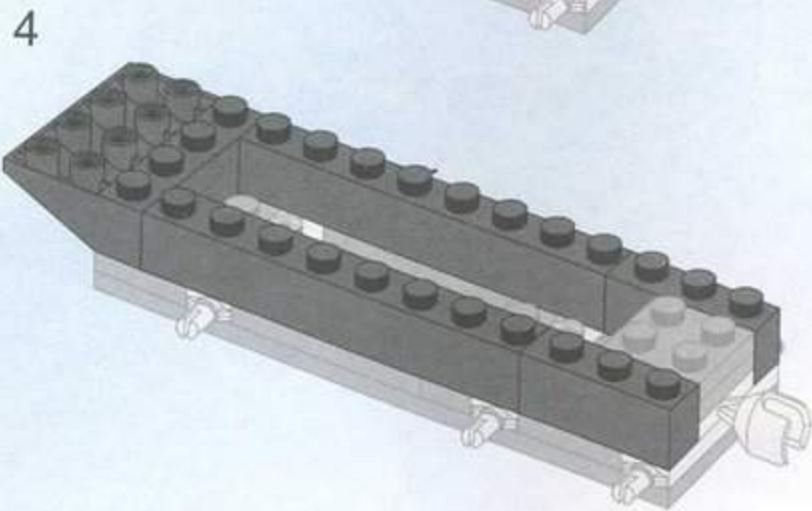
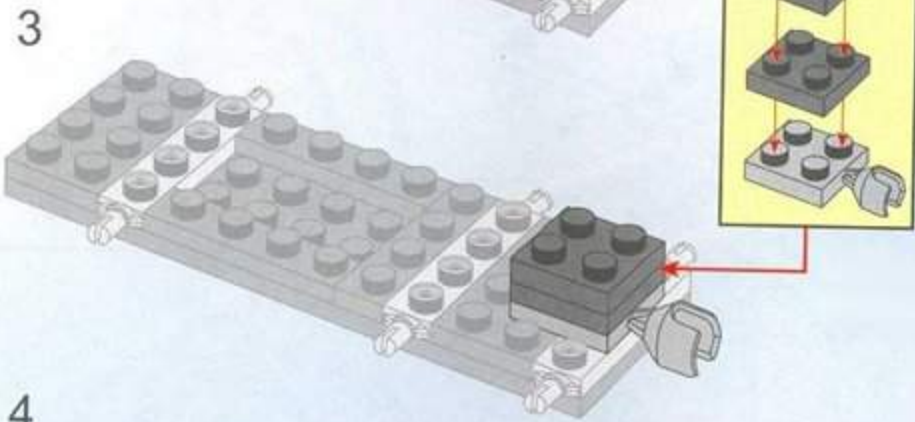
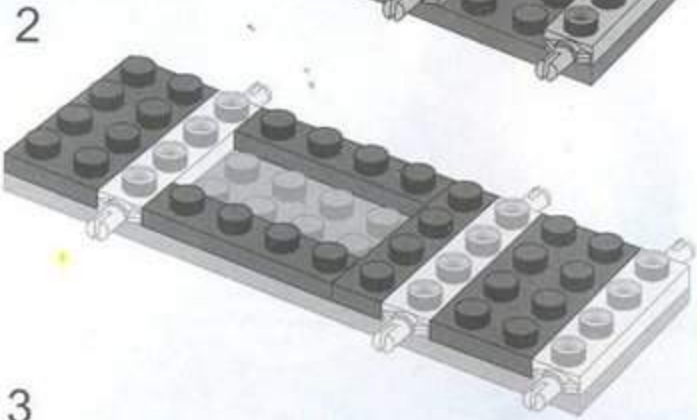
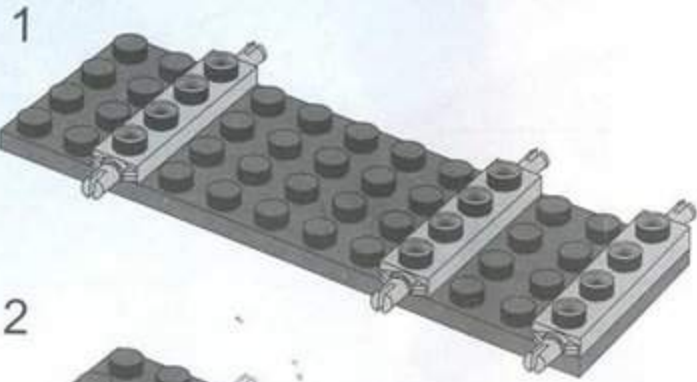

8

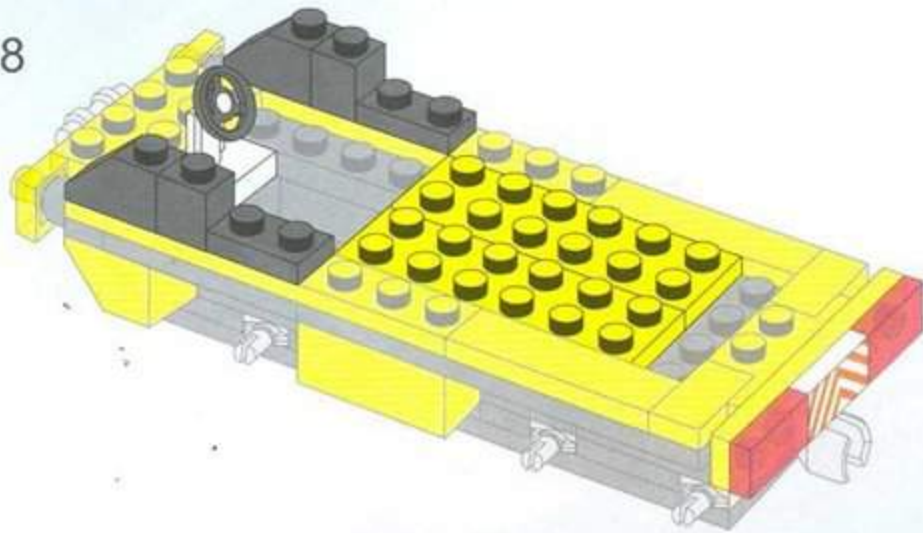

9

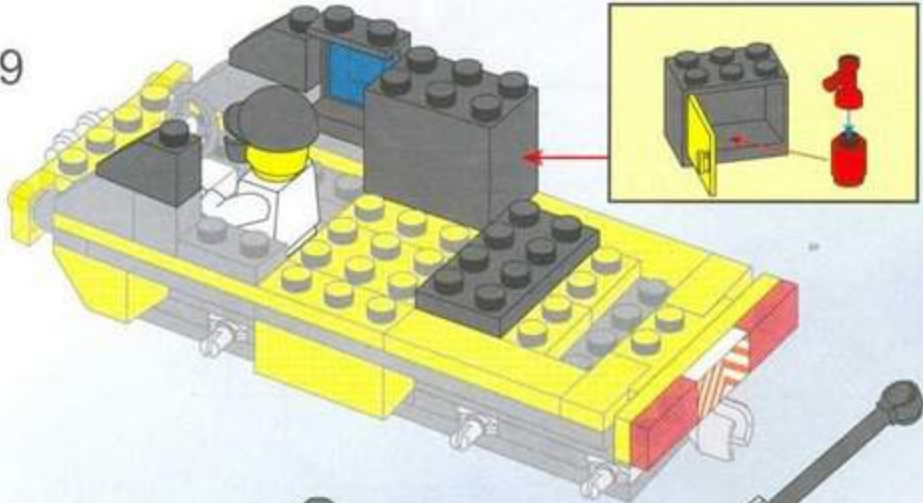

10

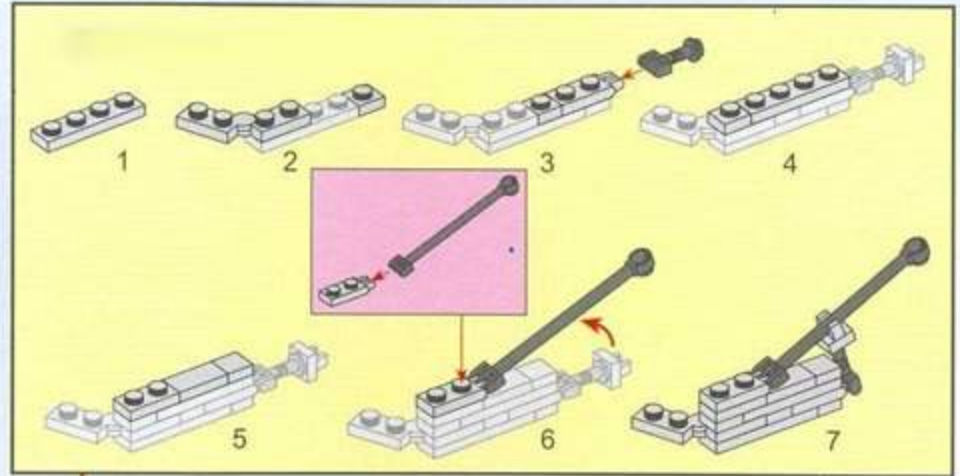
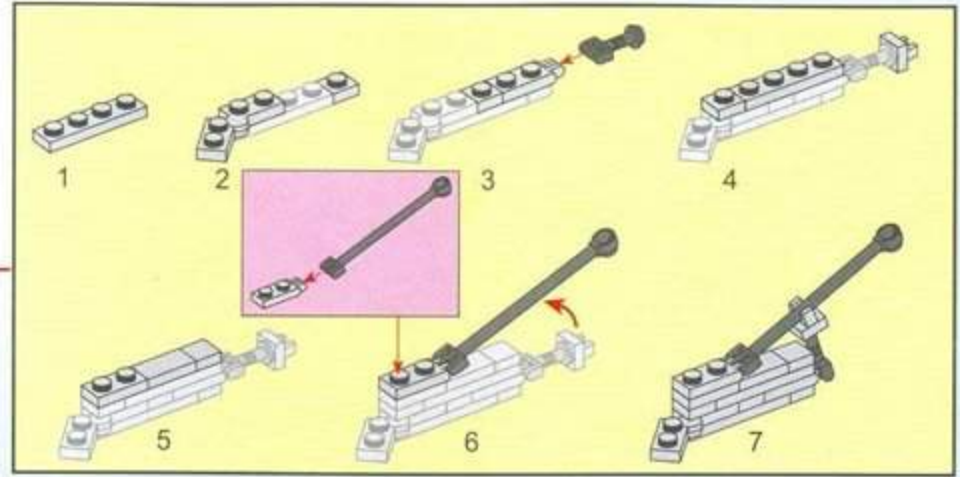
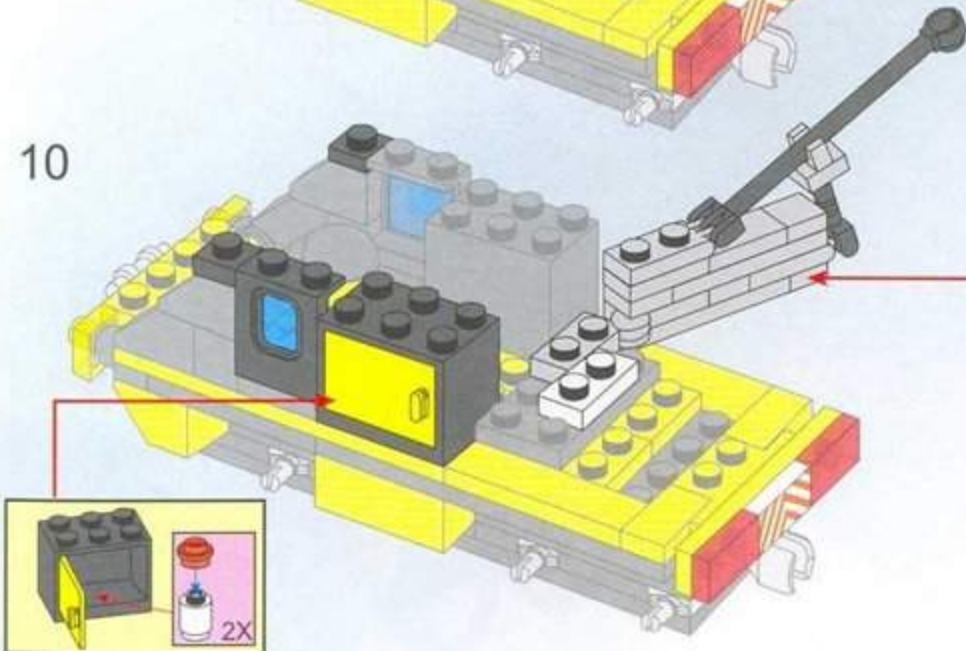

11

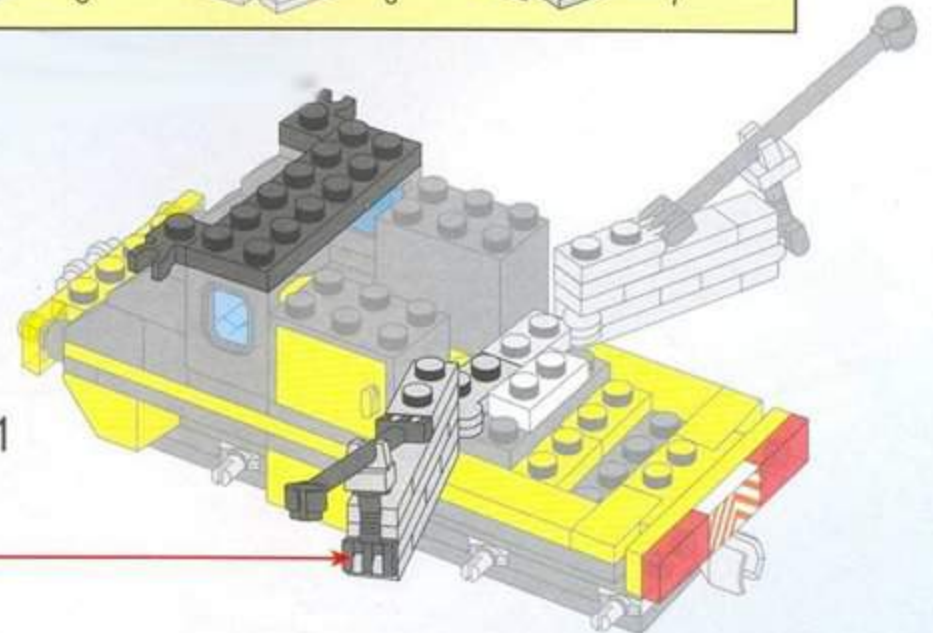



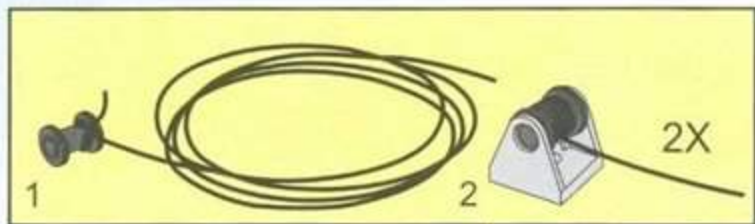

12

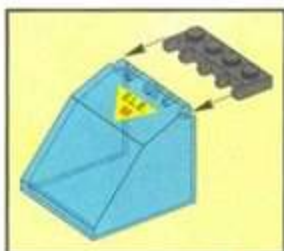
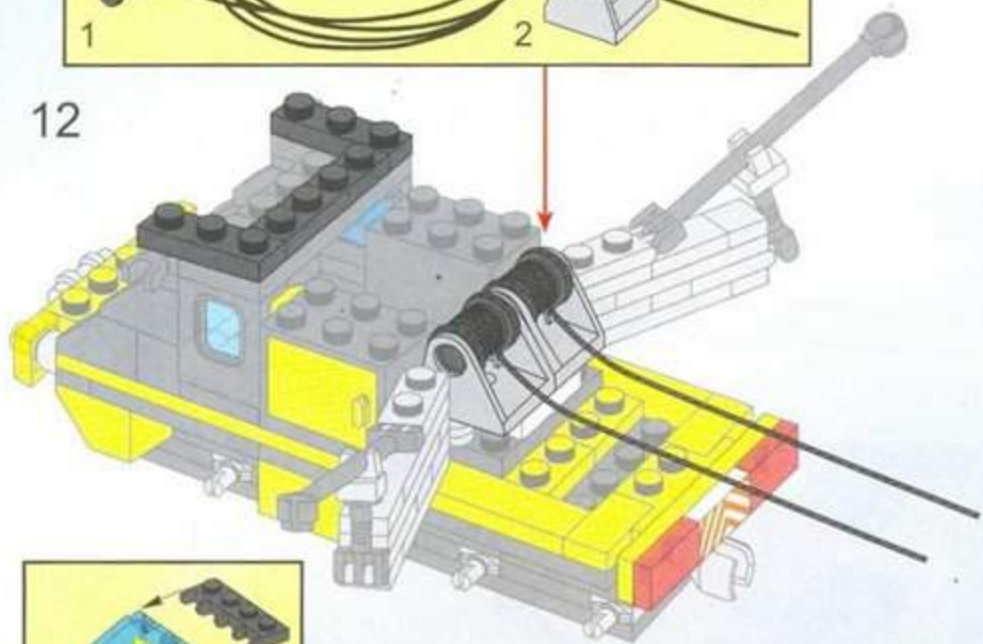

13

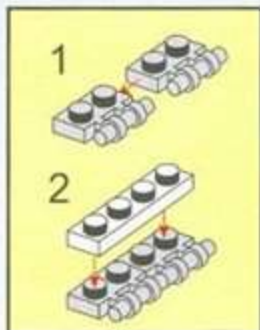
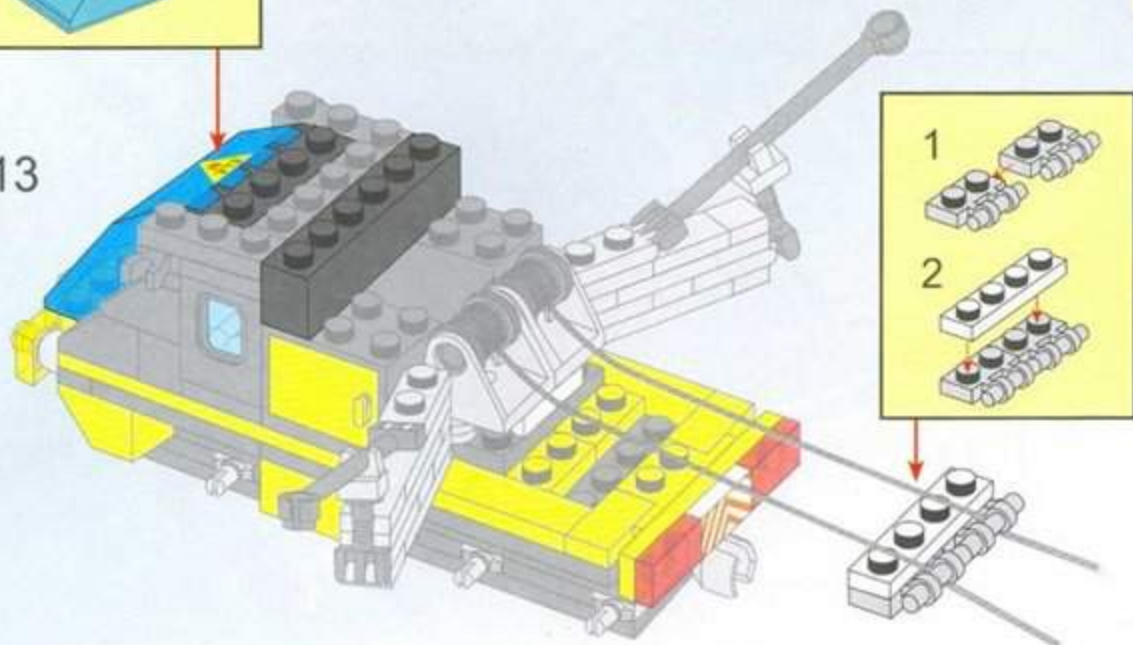

14

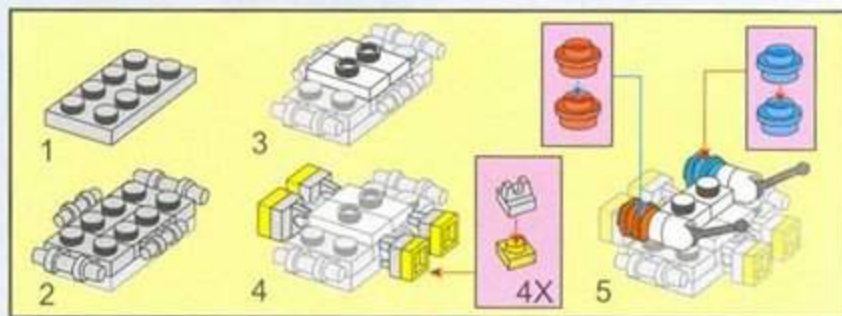
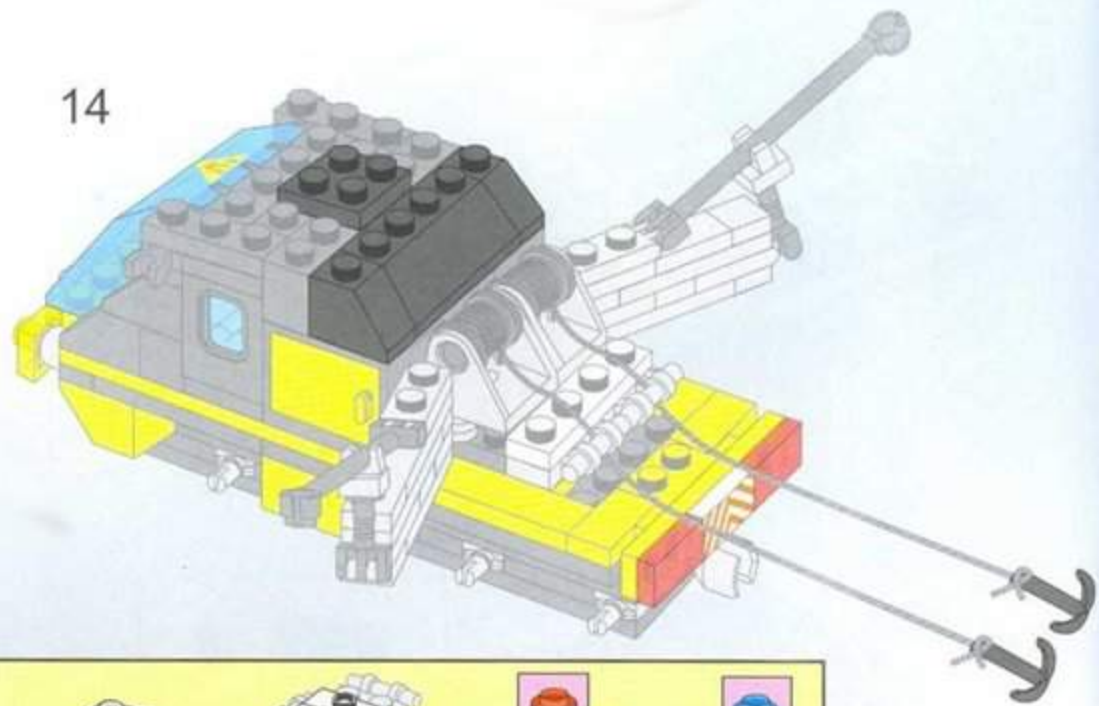

15

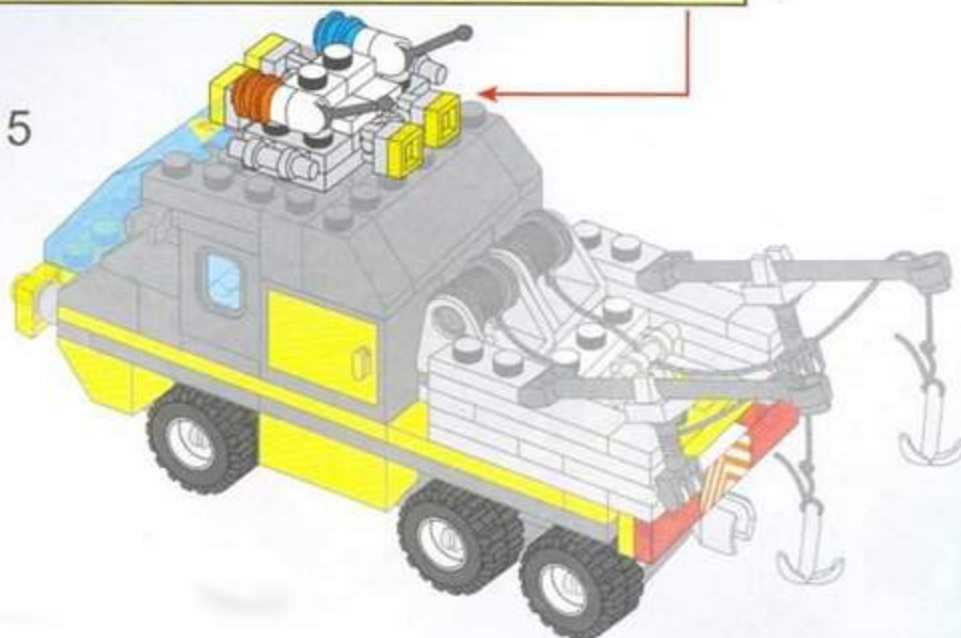

1



2X



2X



5X



1X

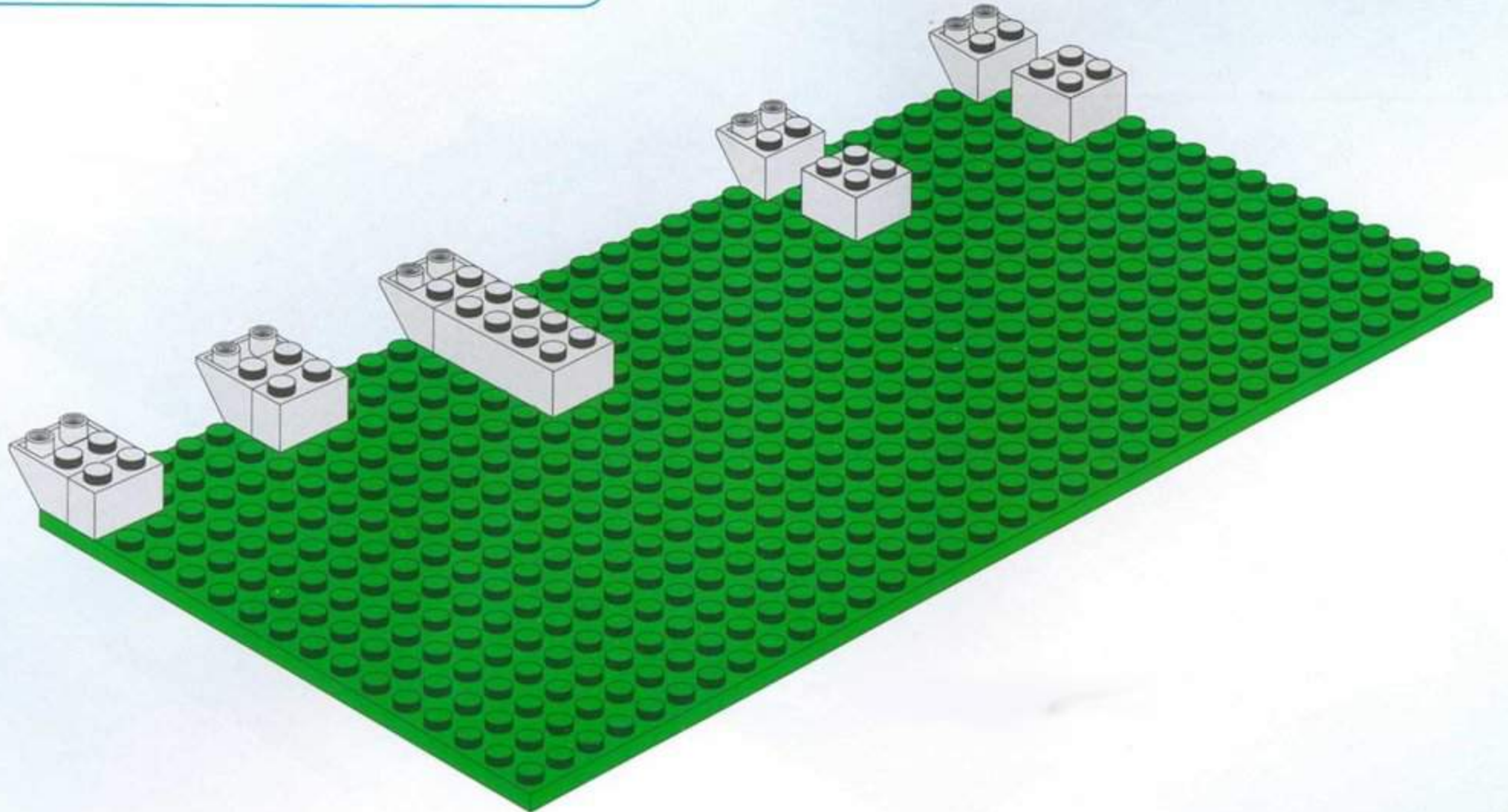

2

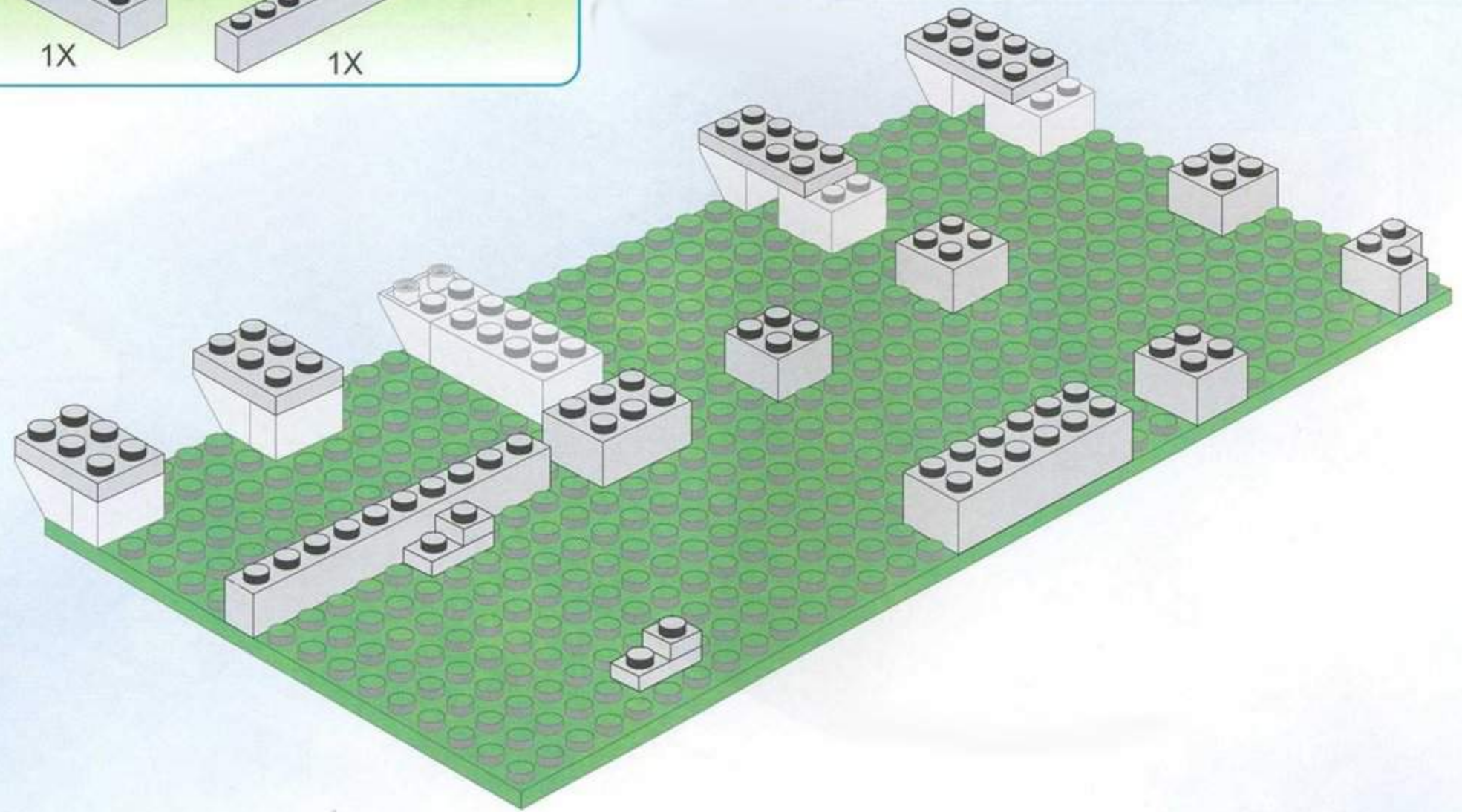
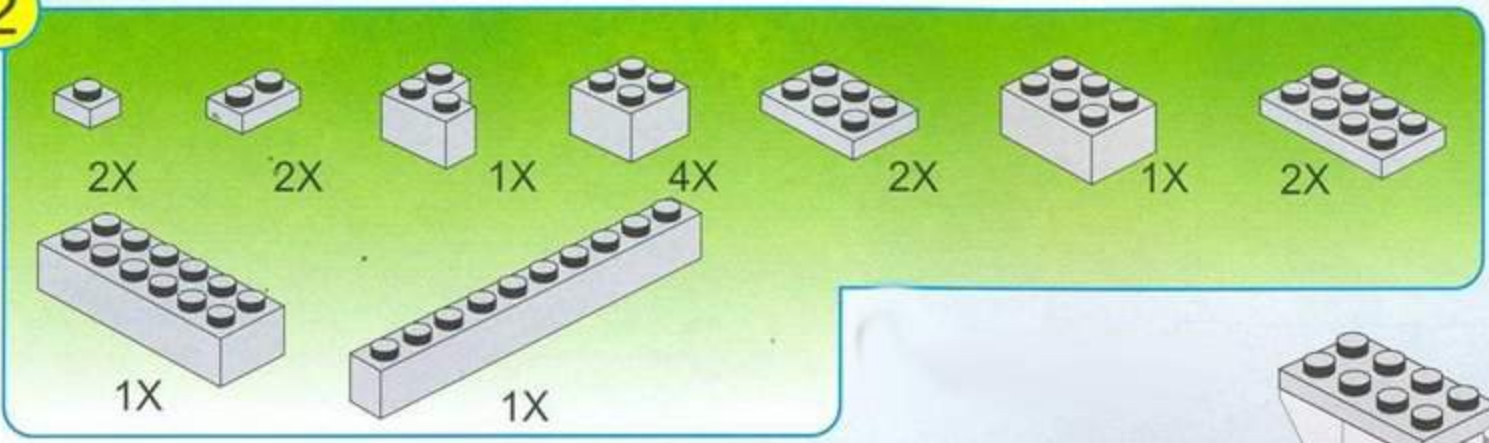

3



1X



1X



1X



2X



1X



2X

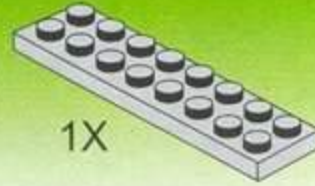

1X

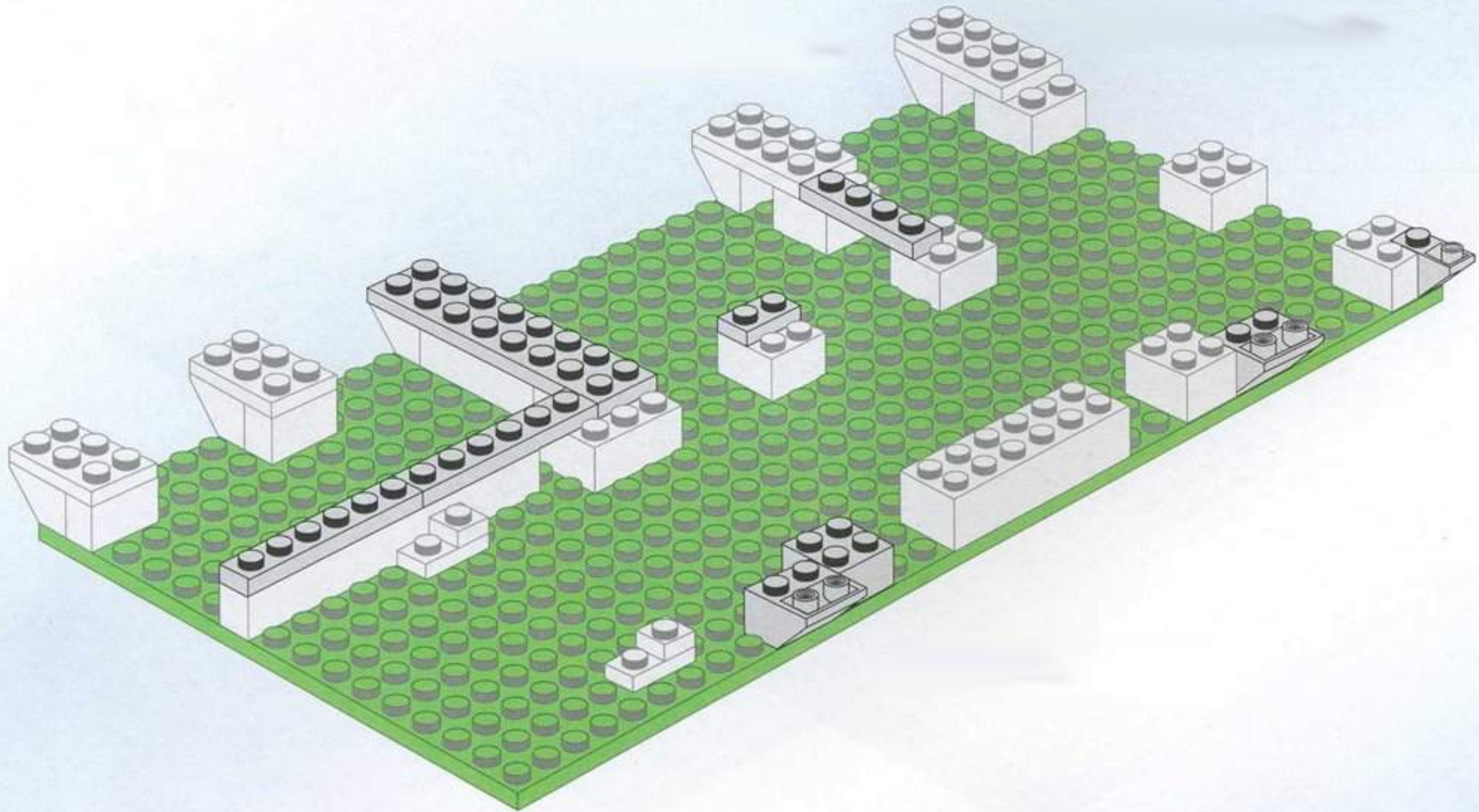

4

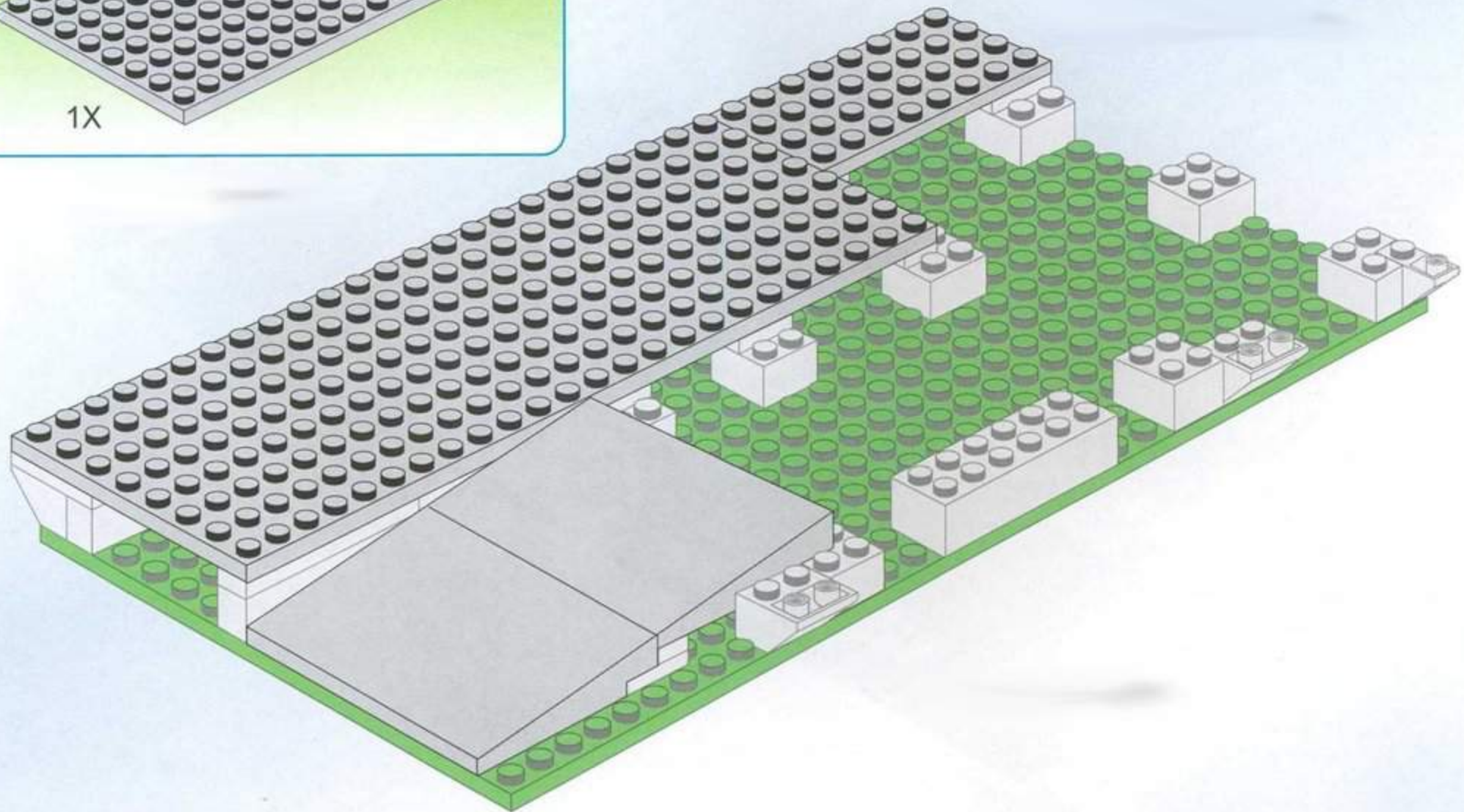
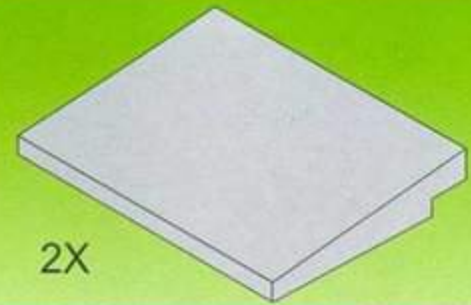
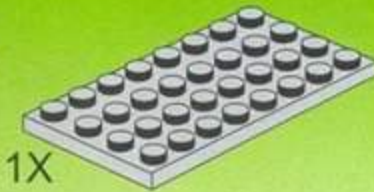
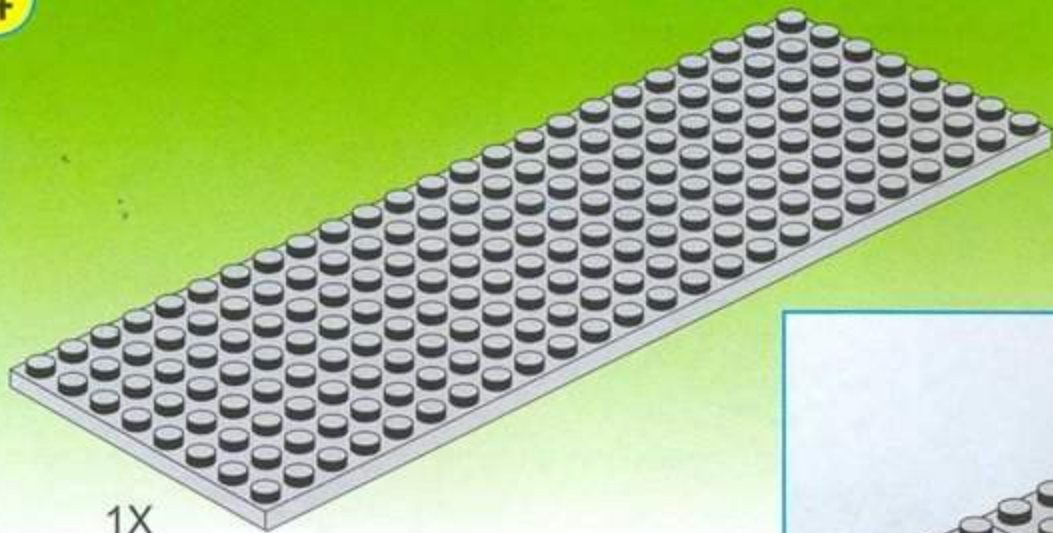

6



2X



2X



1X

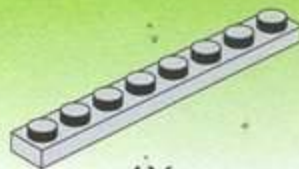

4X



5X



1X

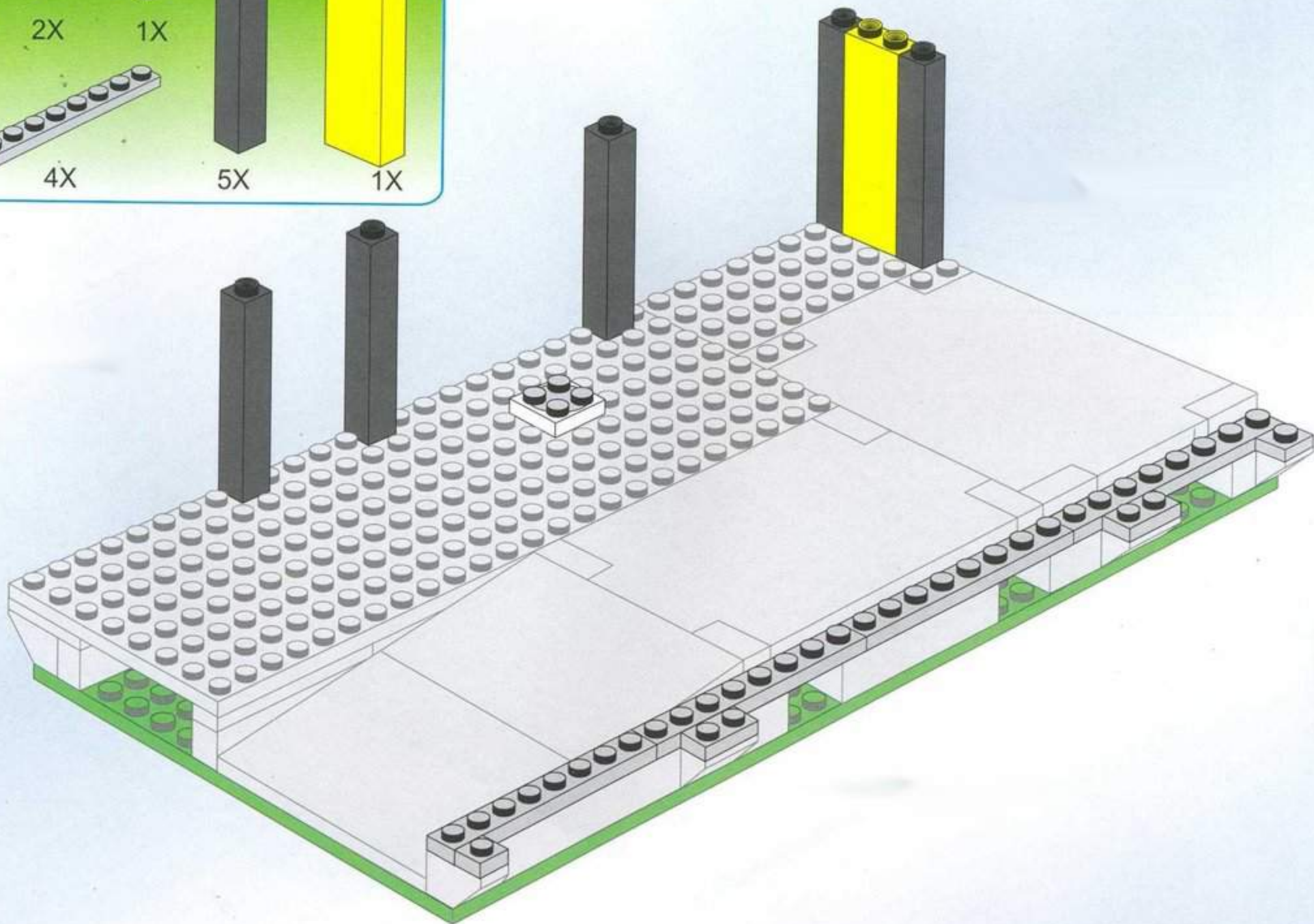

7

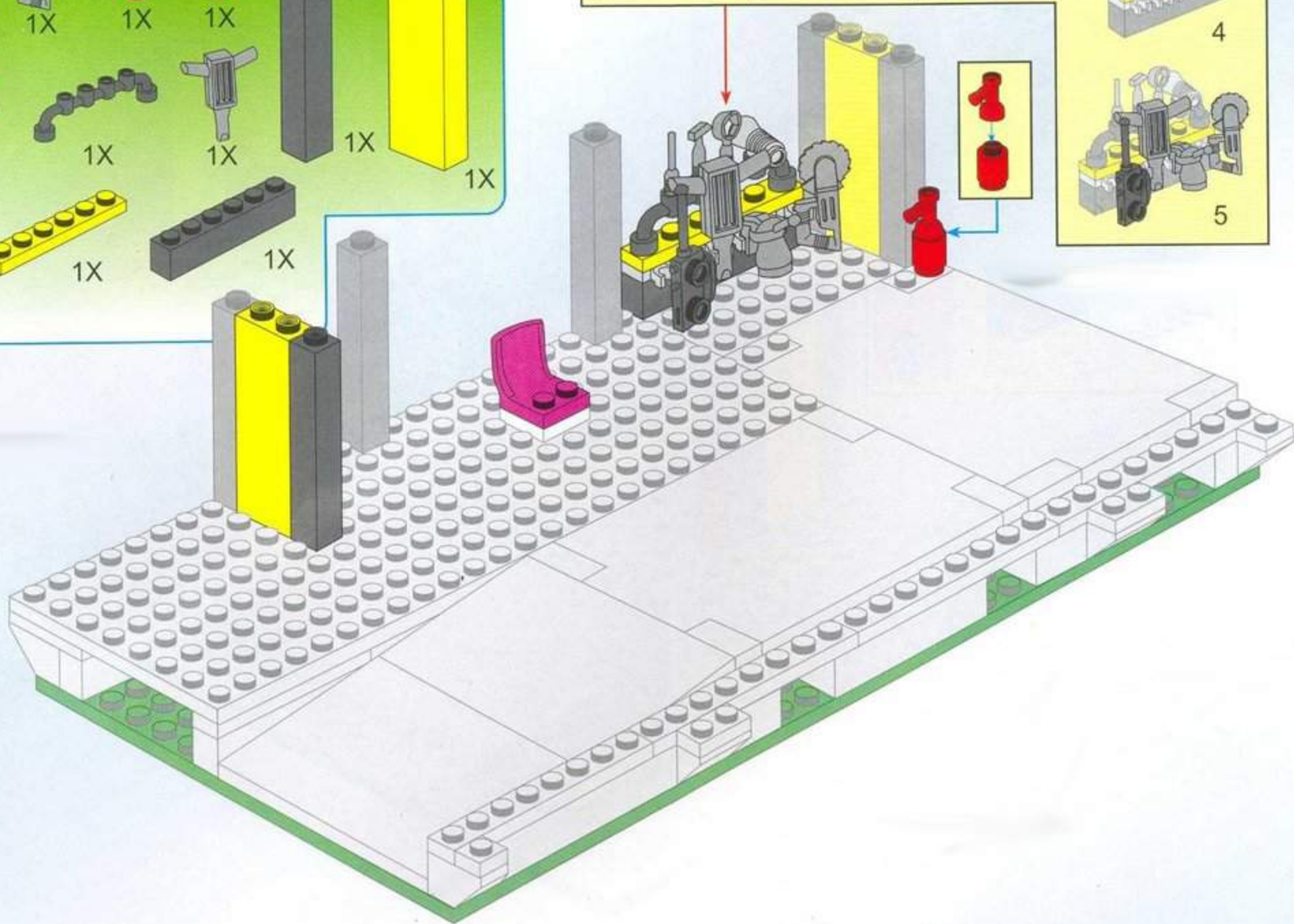
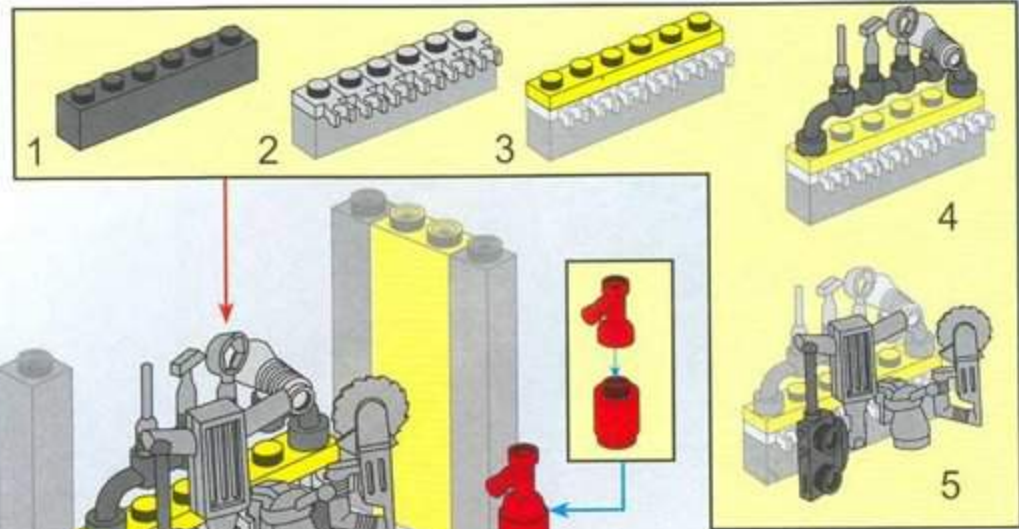
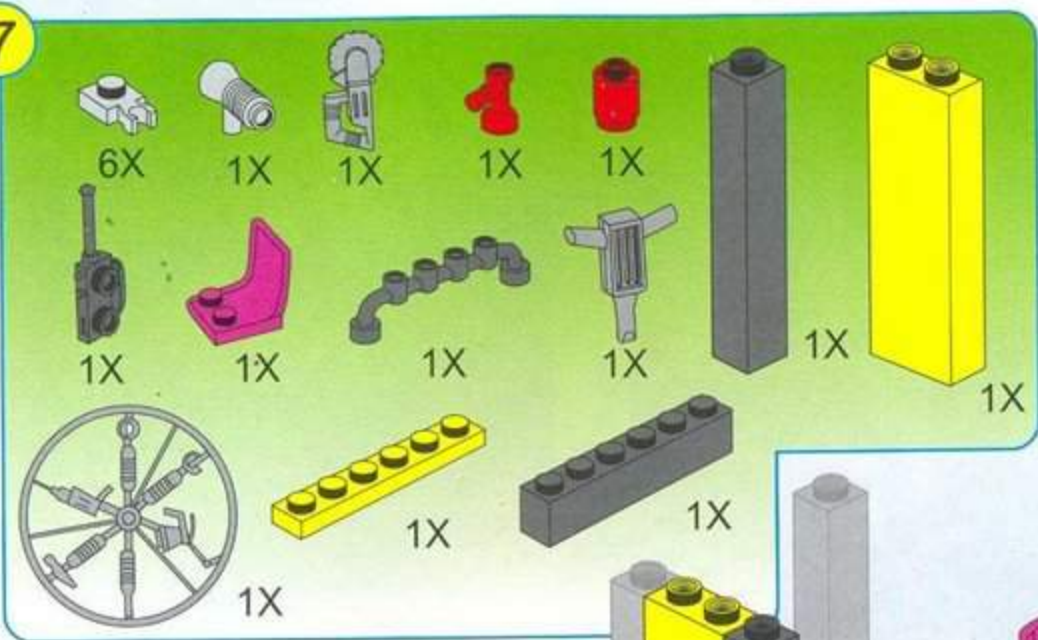

8

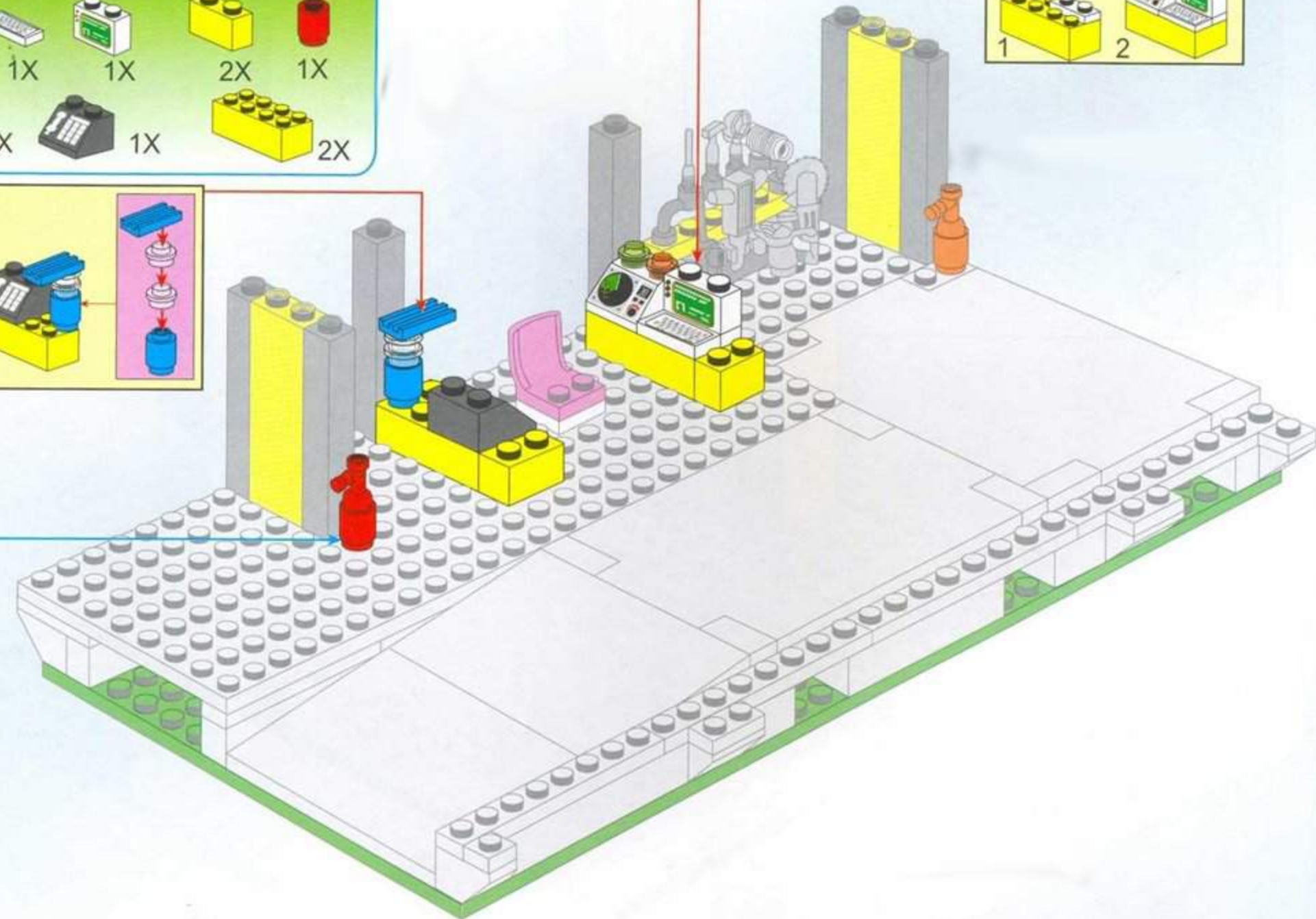
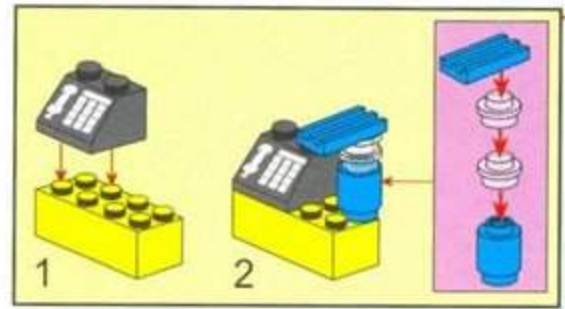
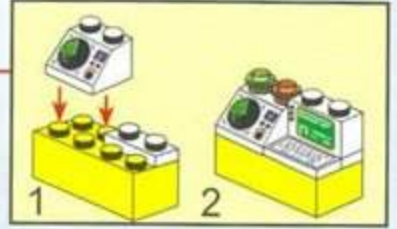
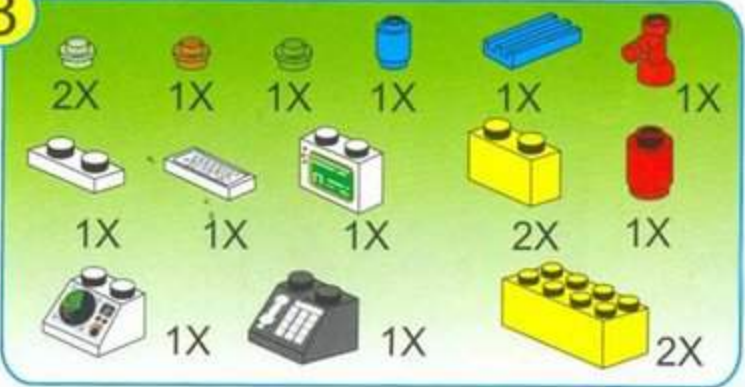



9

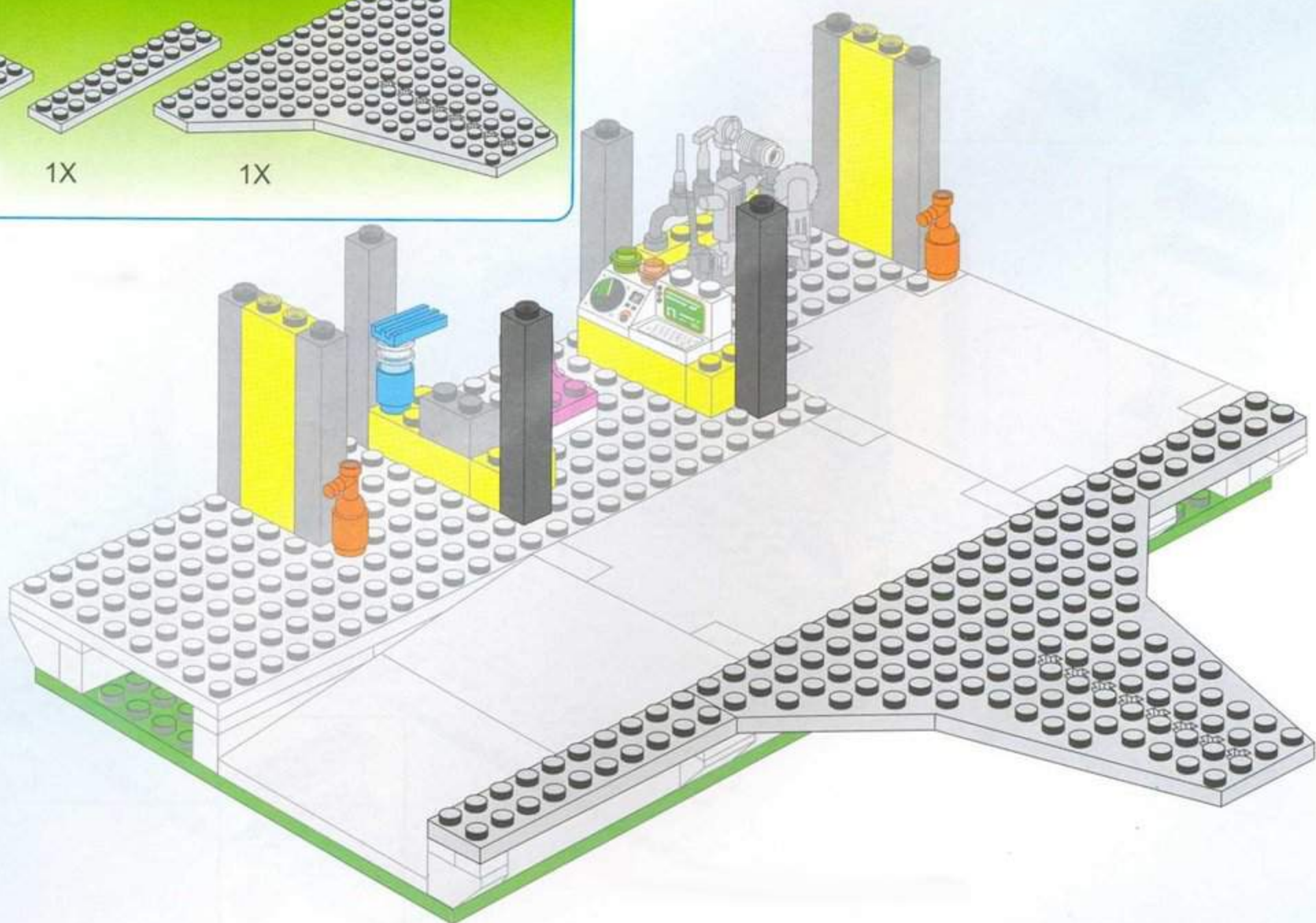
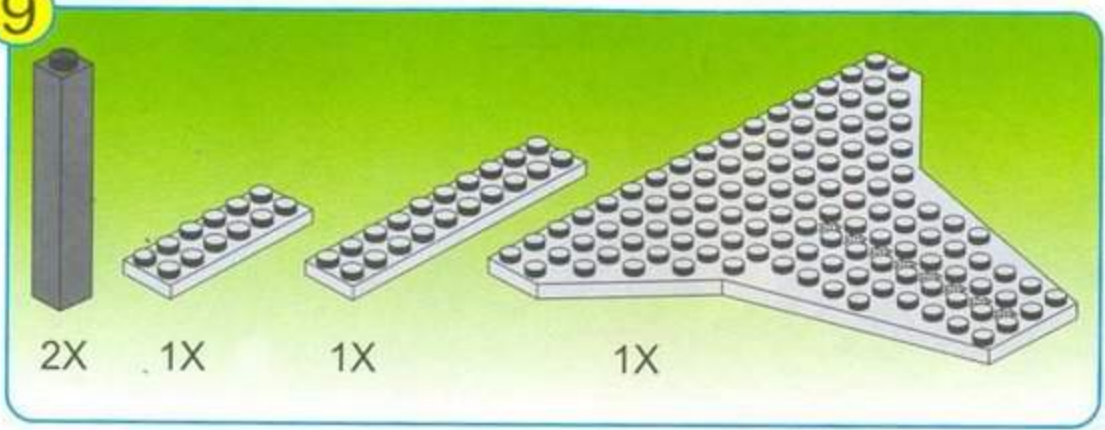

10

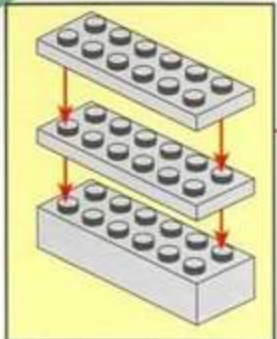
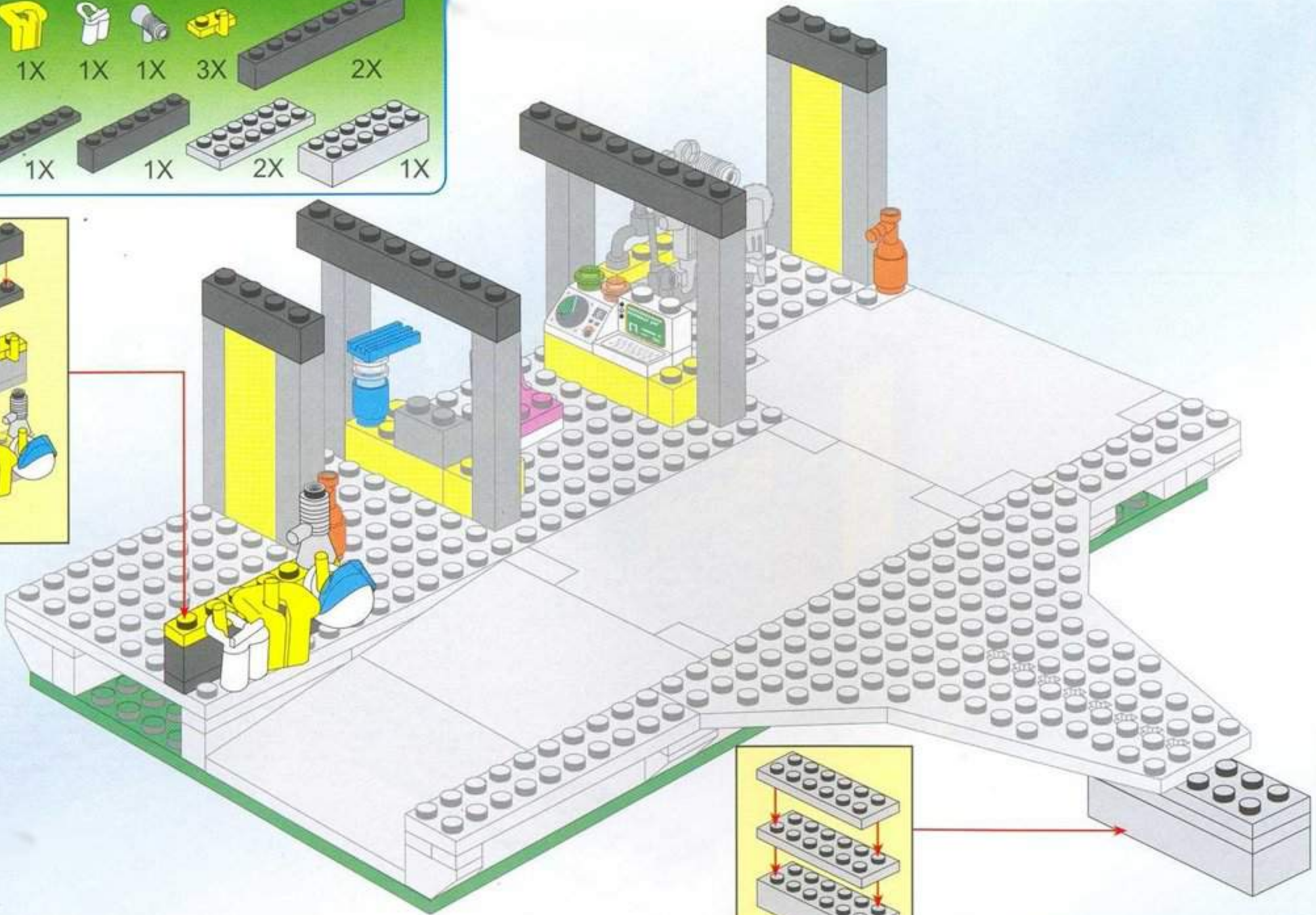
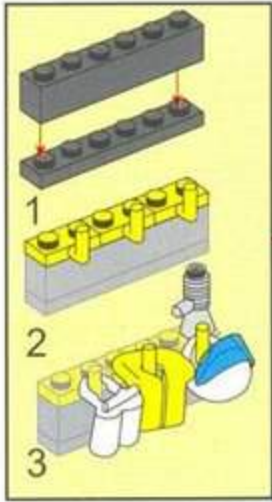
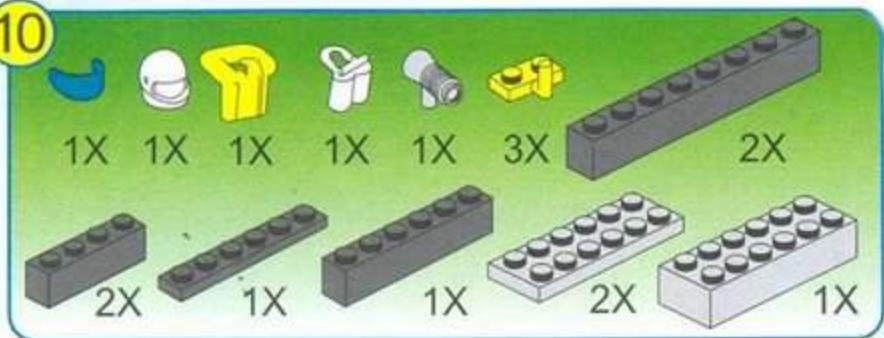

11

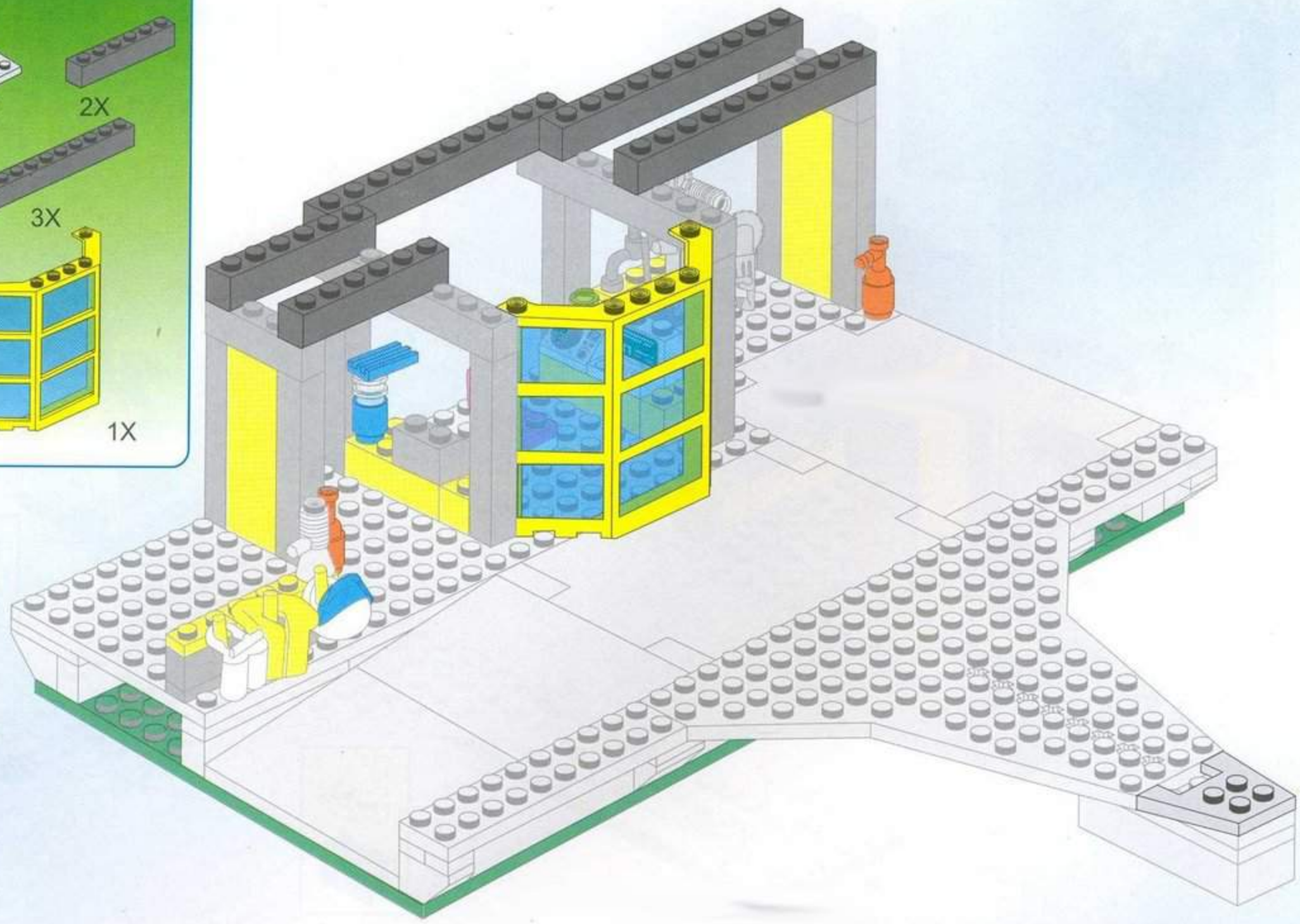
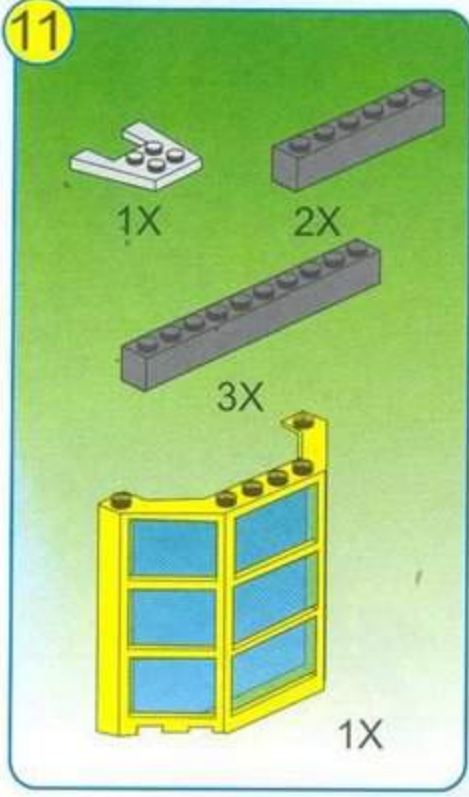

12

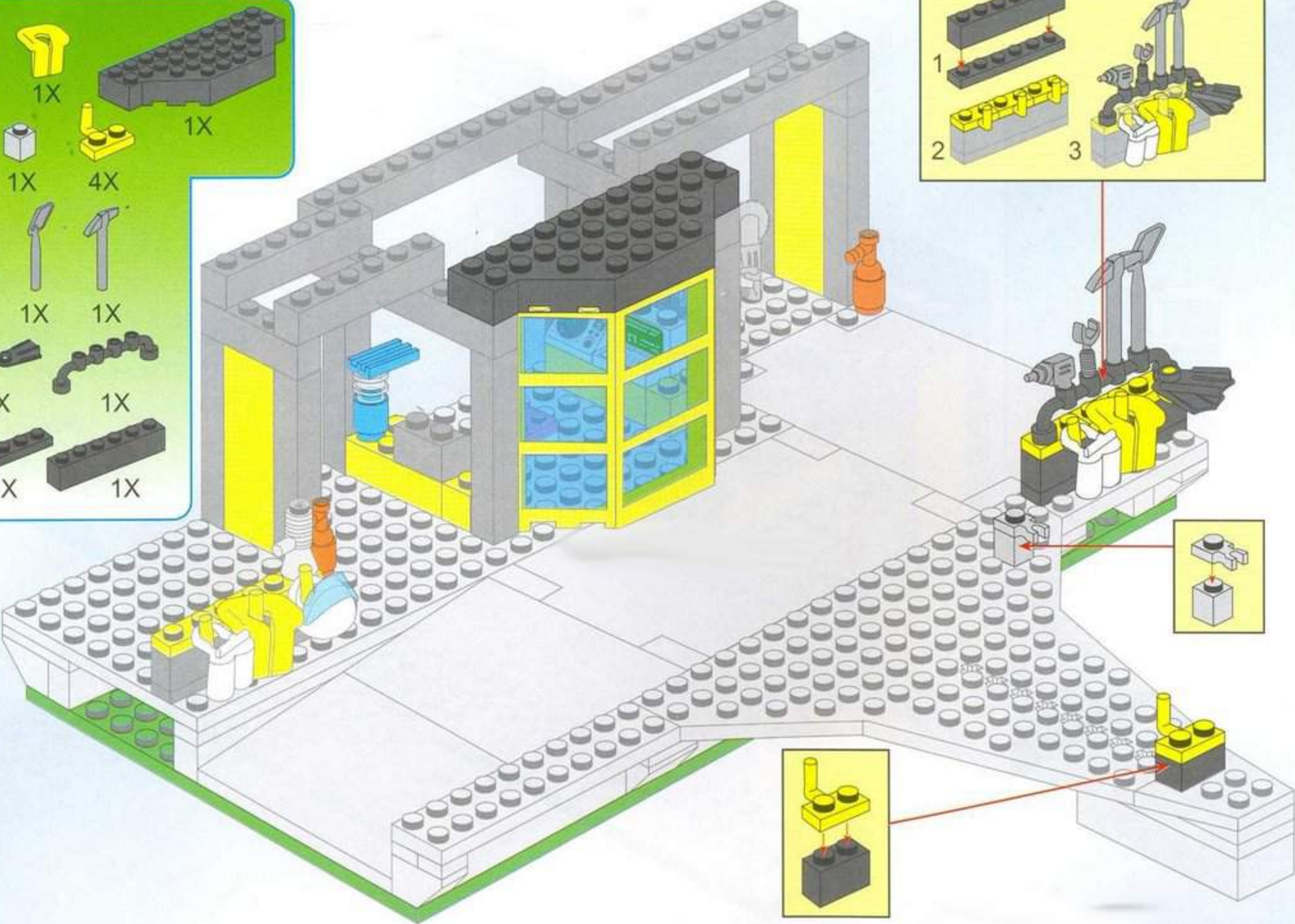
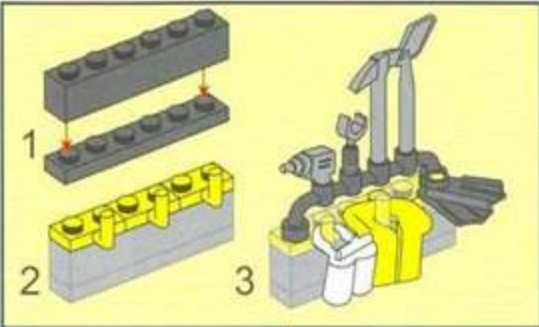
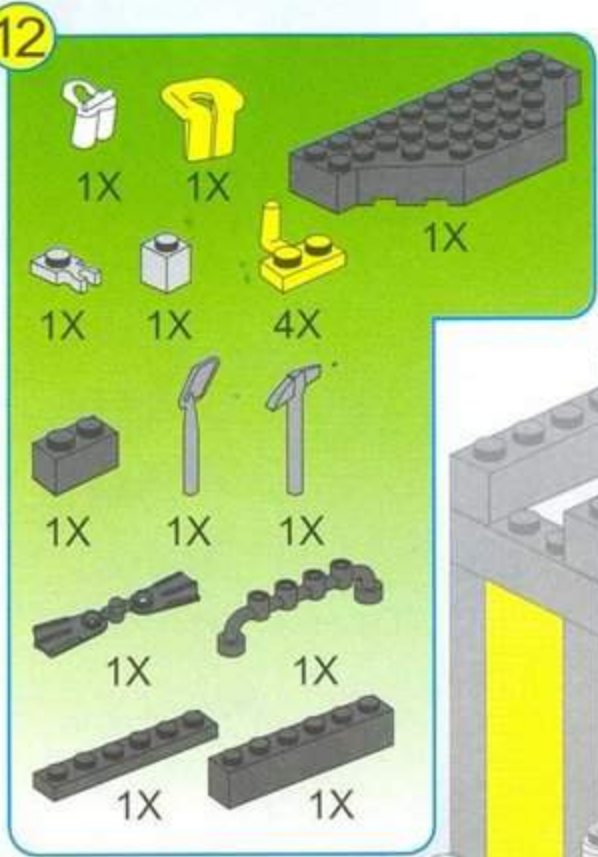

13

1X 1X 1X 1X  
1X 1X 1X  
1X

This inset shows the parts list for step 13: one white axle, one grey axle, one grey motor, one grey axle with a white ball, one red and white axle, one yellow axle, one white axle with a grey ball, and one large grey L-shaped Technic plate.

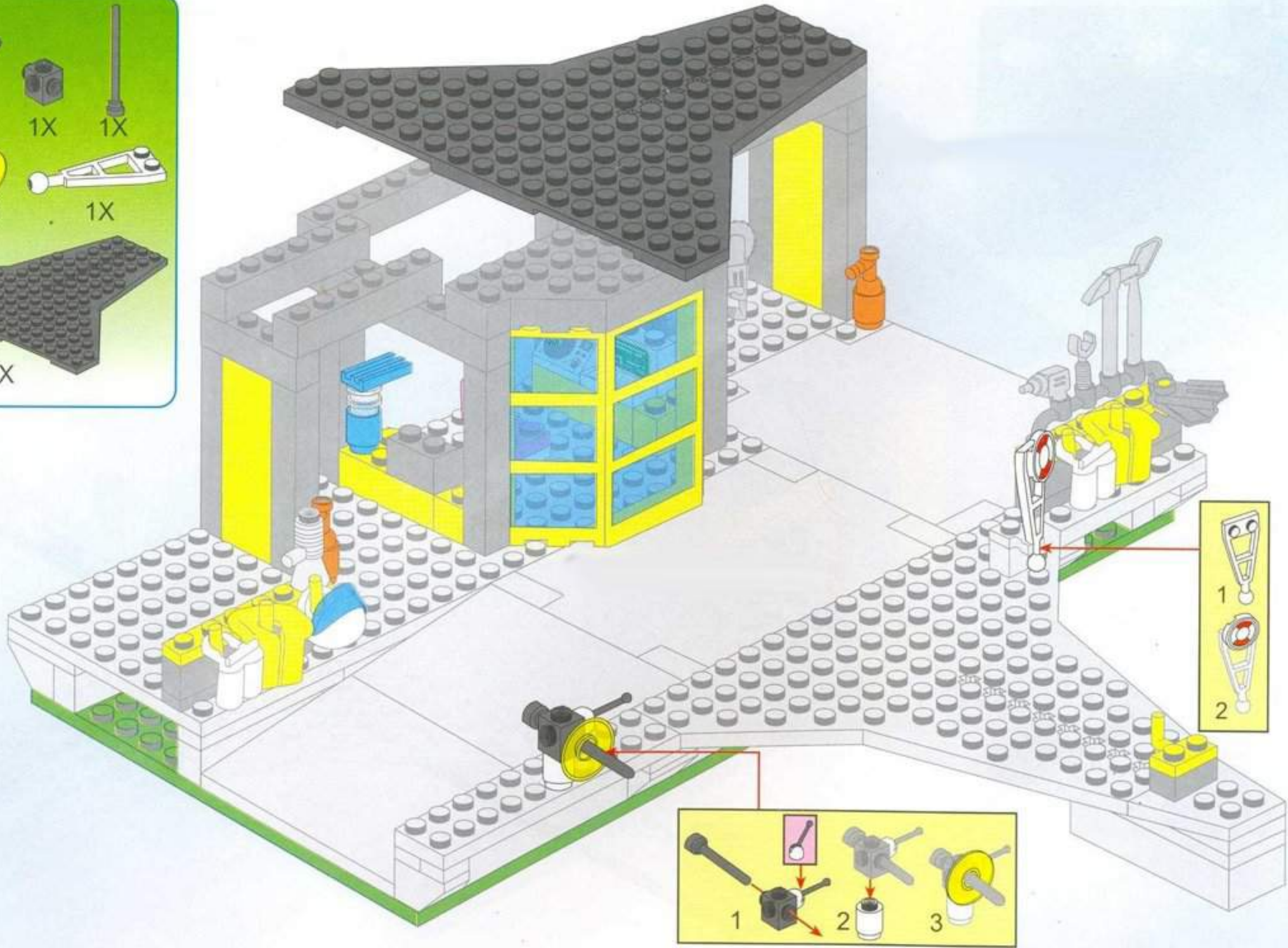

1 2 3

This sub-diagram shows the assembly of a motor. Step 1: A grey motor is inserted into a grey ball. Step 2: A white axle is inserted into the grey motor. Step 3: A yellow axle is inserted into the white axle.

1 2

This sub-diagram shows the assembly of a ball. Step 1: A white axle with a grey ball is inserted into a grey ball. Step 2: A red and white axle is inserted into the white axle.

14

-  1X
-  4X
-  2X
-  1X
-  1X

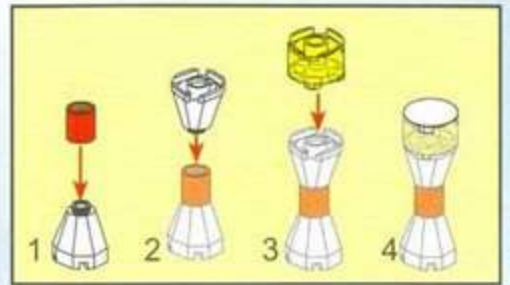
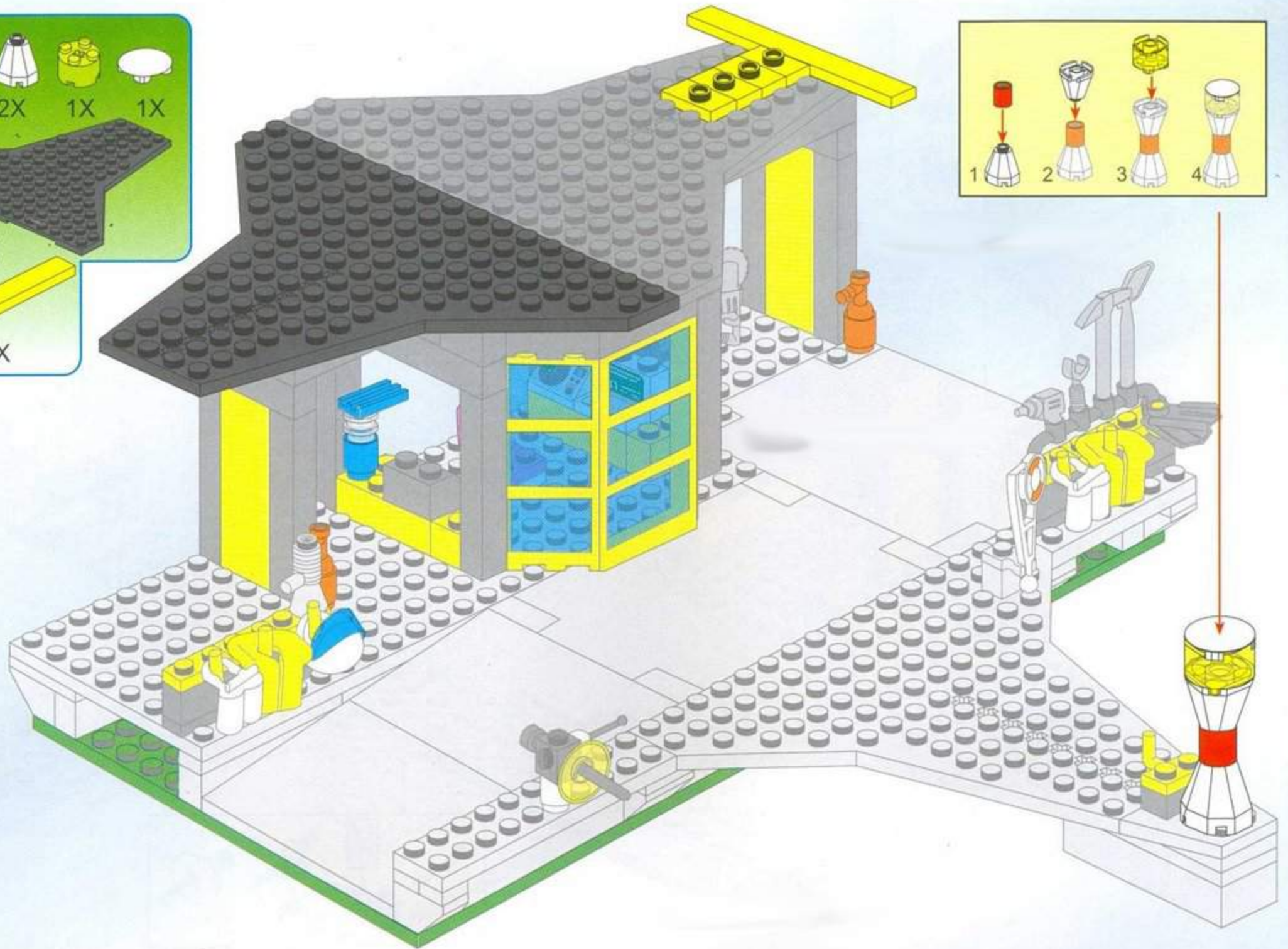
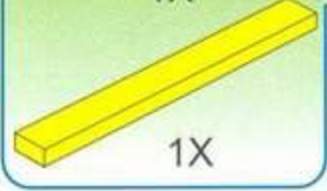

15

- 1X
- 2X
- 1X
- 2X
- 2X

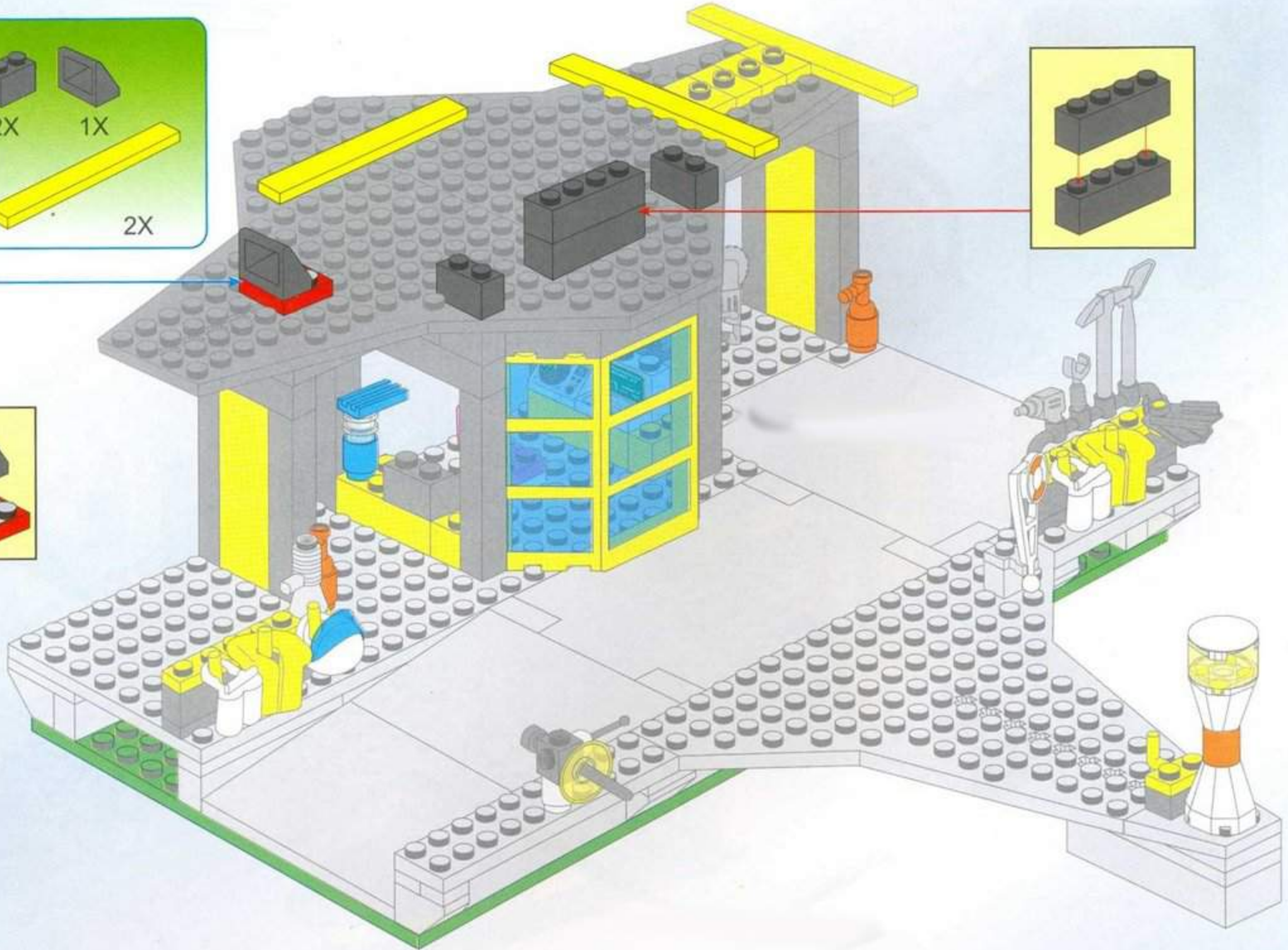
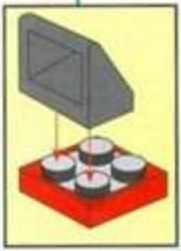
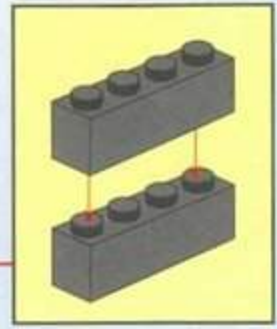



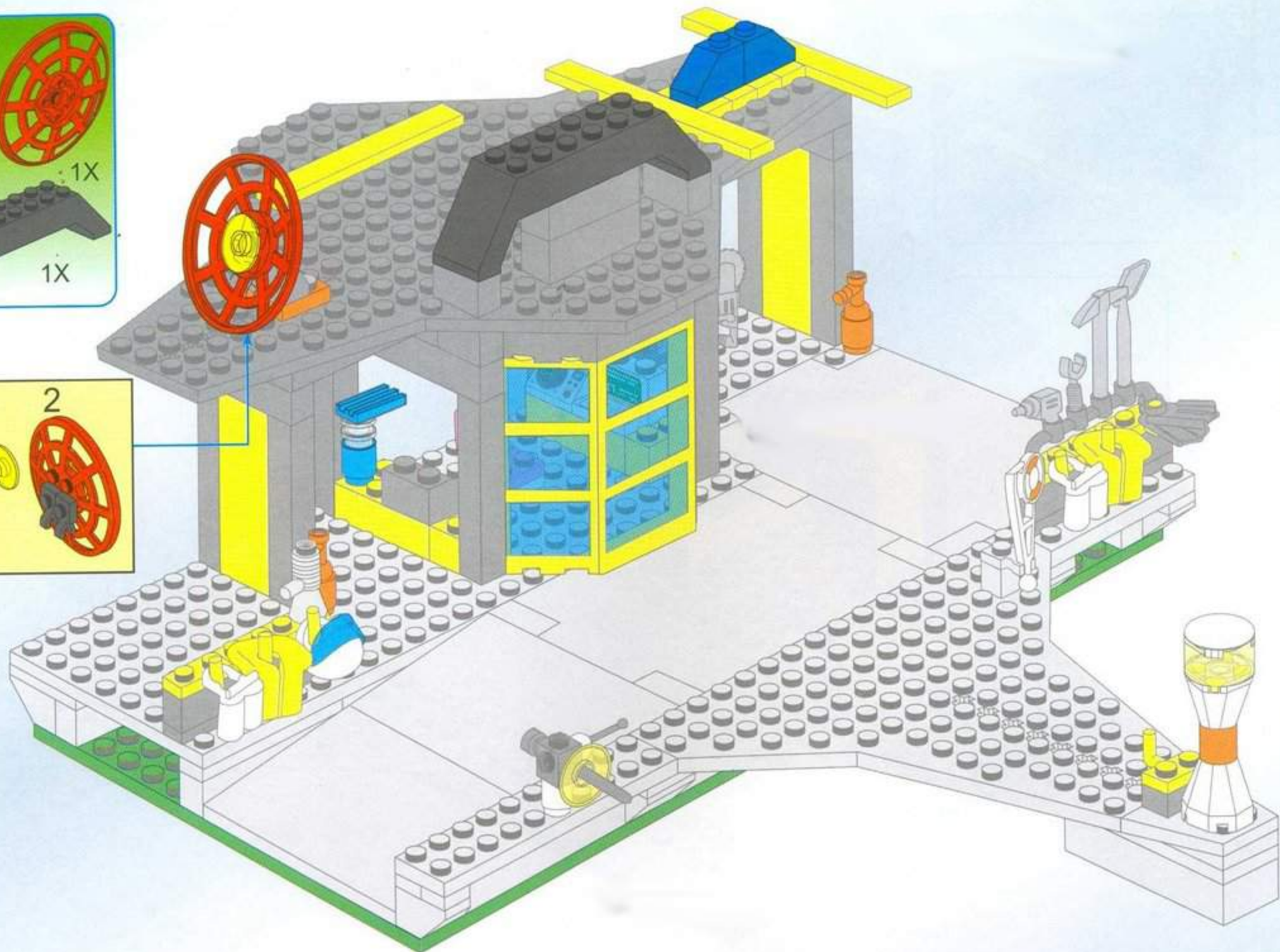
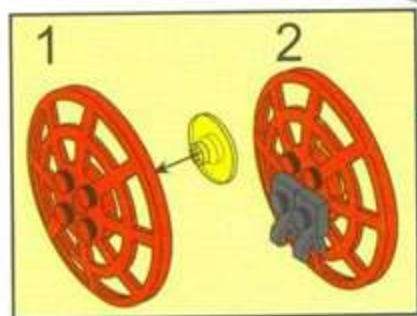

16





17

		
1X	1X	1X
		
		1X

